

MSI-3460

Challenger 3

Operator's Manual



**Measurement Systems
International™**

A RICE LAKE WEIGHING SYSTEMS COMPANY

152161 Rev C

Contents

1.0	Introduction	1
1.1	Safety	2
1.2	General Information	4
1.2.1	User Guide & MSI-3460 Conventions	4
1.3	MSI3460 Annunciators	5
1.4	Specifications	6
1.5	Features	8
1.6	Options	8
1.7	Unpacking	8
1.8	Assembly	9
1.9	Battery Pack	10
1.10	Battery Charger	11
2.0	Operation	12
2.1	Power	12
2.2	Zero	12
2.3	Tare	13
3.0	User Defined Function Keys	14
4.0	Configuration	16
4.1	Menu Map	16
4.2	Function Keys	17
4.3	Auto- Off	18
4.4	Sleep	19
4.5	Display Brightness	20
4.6	Set Points	21
4.7	Total Mode	23
4.8	Units	24
4.9	Filter Setup	25
5.0	Calibration	26
5.1	Initial Calibration	29
5.2	Guidelines for Capacity and Resolution	30
5.3	C-Cal Calibration	31
5.4	Calibration Setup Menu	34
5.5	Standard	34
5.6	Auto Zero Maintenance	35



Technical training seminars are available through Rice Lake Weighing Systems. Course descriptions and dates can be viewed at www.ricelake.com/training or obtained by calling 715-234-9171 and asking for the training department.

6.0	RF Remote Control Option	37
6.1	Description	37
6.2	Functions	37
6.3	Setting the Transmitter Address	37
6.4	Setting the Receiver Address	38
6.4.1	Resetting the MSI-3460 RF Remote Receiver	38
6.5	Contention and Jamming Considerations	38
6.6	Battery Replacement	39
6.7	RF Remote Control FCC Statement	39
7.0	RF Remote Display Option	40
7.1	Introduction	40
7.2	Printer/Serial Output Setup	41
7.2.1	Control Modes	41
7.3	Standard Print Strings	42
7.4	802.15.4 RF Network Setup	44
7.5	FCC Statement (for 802.15.4 Option)	45
7.6	RF Setup Procedure	45
7.7	International RF CERTS (For 802.15.4 OPTION)	47
8.0	Appendix	48
8.1	Troubleshooting	48
8.1.1	Service Counters	50
8.2	Software Update for use with SC3 PCA	51
8.3	MSI-3460 Challenger 3 Dimensions	54
	The MSI Limited Warranty	55



Rice Lake continually offers web-based video training on a growing selection of product-related topics at no cost. Visit www.ricelake.com/webinars.

1.0 Introduction

The *MSI-3460 Challenger 3* is a combination of the sound and proven mechanical design of the industry standard Challenger with today's most advanced electronics. It provide a superb feature set unmatched by any scale in its class or price range. The multi-purpose hanging scale is ideal for situations in which headroom is at a minimum. The *MSI-3460* is versatile, reliable, accurate and easy to operate. The *MSI-3460* is designed to meet or exceed the requirements of all regulatory agencies. RF remote control and remote display options are available to further enhance the safety and usability of the *MSI-3460*.

Please take the time to read this manual completely through before attempting to use the *MSI-3460*. Although designed for easy set up and use, a thorough understanding of this manual will ensure that you receive the maximum benefit from the system.

If you have any questions or comments, please contact

Measurement Systems International

Phone (toll free): 1-800-874-4320



Manuals can be viewed or downloaded from the Measurement Systems International site at:
www.msiscales.com

1.1 Safety

Safety Symbol Definitions:



Indicates a potentially hazardous situation that, if not avoided, could result in serious injury or death, and includes hazards that are exposed when guards are removed.



Important

Indicates information about procedures that, if not observed, could result in damage to equipment or corruption to and loss of data.

General Safety



Do not operate or work on this equipment unless you have read and understand the instructions and warnings in the Installation, Operators Manual. Contact any Measurement Systems International dealer for replacement manuals. Proper care is your responsibility.



Failure to heed may result in serious injury of death.

DO NOT allow minors (children) or inexperienced persons to operate this unit.

DO NOT stand near the load being lifted as it is a potential falling hazard. Keep a safe distance.

DO NOT use for purposes other than weight taking or dynamic load monitoring.

DO NOT use any load bearing component that is worn beyond 5% of the original dimension.

DO NOT use the scale if any of the components of the load train are cracked, deformed, or show signs of fatigue.

DO NOT exceed the rated load limit of the scale, rigging elements, or the lifting structure.

DO NOT allow multi-point contact with the hook, shackle, or lifting eye of the scale.

DO NOT allow high torque on the scale unless it is specifically designed for high torque.

DO NOT make alterations or modifications to the scale or associated load bearing devices.

DO NOT use improperly rated or sized shackles. Use only MSI recommended shackles.

DO NOT remove or obscure warning labels.

For guidelines on the safe rigging and loading of overhead scales and dynamometers, read the "MSI Crane Scale Safety and Periodic Maintenance Manual" (available at www.msiscal.com).

Keep hands, feet and loose clothing away from moving parts.

There are no user serviceable parts within the MSI-3460. Any repairs are to be performed by qualified service personnel only.

5 Digit 1.5"/3.8mm
high brightness LED
weight display



Figure 1-1. MSI-3460 Front Panel

Key Descriptions



Power Key - Turns the *MSI-3460* on and off.



Zero Key - Used to zero out residual weight on the scale.



Tare Key - removes weight of containers, trucks or carriers and places the scale in the Net weight mode.

TARE key functions tare in, tare out.

To see the gross weight without resetting the tare value, you must program the USER key as NET/GROSS.



User Key- Programmable to user selectable functions. These are described in the USER key Setup section. This key is defaulted to the TEST function.

1.2 General Information

1.2.1 User Guide & MSI-3460 Conventions

1. Keys used in operations are printed in **BLUE** and capitalized.
2. Screen shots that are used in menus are displayed in **RED** and shown in a 7-segment font. Not all characters can be displayed with this font, but a close approximation is shown.
3. If a function key does not work, it is probably because the *MSI-3460* is not setup to support the key. For example, if the User key is set for **TOTAL**, you must also set up the **TOTAL** mode in the Setup Menu.
4. When in Setup menus, the **ZERO** key drops back one menu level. At the root menu level, the **ZERO** key stores the changes and returns to the weight mode.
5. When in Setup menus, the **POWER** key returns you directly to the weight display without storing the changes.
6. When in Setup menus, the **USER** key functions as the scroll key.
7. When in Setup menus, the **TARE** key functions as the ENTER/SELECT key.

1.3 MSI3460 Annunciators

The *MSI-3460* uses blue and red LEDs to indicate weight mode and other information.

MOTION	Blue LED - Indicates that the weight has not settled within the motion window (usually $\pm 1d$). While this symbol is illuminated, the scale will not zero, tare or totalize.
→0←	Center-of-Zero – Blue LED - Indicates the weight is within 1/4d of zero.
PEAK	Blue LED - Indicates the scale is in peak hold mode.
NET	Blue LED - Indicates the scale is in Net weight mode. A tare weight is subtracted from the gross weight.
GROSS	Blue LED - Indicates the scale is in the Gross weight mode. All hook weight is displayed minus any zero offset.
TOTAL	Blue LED - Indicates the scale is displaying the Total weight. This is a temporary display lasting less than five seconds.
X1000	Blue LED - Usually used in conjunction with the TOTAL LED allows accumulation of weight beyond the five digit display capacity.
LO BATT	Appears when approximately 10% of battery life remains and blinks when automatic shutdown is imminent.
kg	Red LED - Indicates weight display is in kilograms.
lb	Red LED - Indicates weight display is in pounds.
SET POINTS	User programmable set points for early overload warnings. Blue LED - Setpoint 1 and 2 Red LED - Setpoint 3
ACK	Acknowledge LEDs are used to provide feedback to the operator Blue LED - Incoming remote commands have been received Red LED - Light briefly once executed. Also used for acknowledging successful Auto-Total operations.
RF	Blue LED - Indicates carrier detect for RF remote display equipped <i>MSI-3460</i> . If the LED is illuminated, <i>MSI-3460</i> and remote display are linked. On units equipped with the RF remote control, the LED is illuminated when a remote command is received and for the next half second.

1.4 Specifications

Accuracy	$\pm(0.1\% + 1d)$. 'd' equals one displayable increment.
Resolution	Standard displayed resolution: 2500-3750'd'. Resolutions to 10000'd' (non LFT units only) are possible. Internal A/D resolution 24 bits.
Standard Capacities	lb 250 500 1000 2000 5000 10,000 15,000 kg 125 250 500 1000 2500 5000 7500
Power	Battery operated, 6V rechargeable sealed lead acid battery pack (standard Challenger Charger) Typically 50 hours of battery life with automatic sleep mode and automatic power off.
Display	Five digit, large 1.5 in (38 mm) numeric red GaAlAs Light Emitting Diode (LED)
Operating Temp	-40°F to +122°F (-40°C to +50°C), LFT range -10°C to +40°C
Operating Time	50 hours typical/100 hours max. (depends on operating mode)
Enclosure	NEMA 4/IP65 powder coated alodined cast aluminum
Load Cell	Standard 350 Ω Bridge, S-Beam
USER	Programmable multifunction button for use as TEST, TOTAL, UNIT, PEAK, NET/GROSS, VIEW TOTAL, LEARN (for RF Remote Control), HI-RES
CAL	Front panel calibration switch (located behind wire sealable screw) Initiates full digital calibration procedure
Auto Zero Maintenance	Standard, can be disabled internally
Auto-Off Mode	Prolongs battery life by turning POWER off after 15, 30, 45 or 60 minutes (operator determined) of no scale activity
Auto-Sleep Mode	Prolongs battery life by dimming LED display after 5, 15, or 30 minutes of no activity
Units	kg, lb (other units available with custom calibrations)
Filtering	Selectable: OFF, Low (LO), Medium (HI-1), High (HI-2)
Totalization	Standard: Press button or automatic; TOTAL weight up to 99999 X 1000 kg or lb
Peak	Uses unfiltered faster reading of A/D, (>220 readings per second)
Setpoints	Three internal standard setpoints and three ultra bright LEDs on front panel
Service Counter	Two independent 32 bit registers; register 1 updated each time weight exceeds 25% of capacity; register 2 updated each time weight exceeds overload; when register 1 exceeds 16383 or register 2 exceeds 1023, display reads "Cnt" for load cell counter; Test function shows the two readings in order
Construction	All of these features are housed in a single, low-profile, cast aluminum housing consisting of three sections: The front of the scale houses the display, controls and all electronics The center section contains the load cell, lifting eye and hook The rear of the scale features a quick access battery compartment

Table 1-1. Specifications

OPTIONS	
Wireless Remote Controller	50' (15 m) typical range Light-of-Sight. Uses 418 MHz (USA) handheld transmitter.
802.15.4 RF Modem for connectivity with MSI-8000 RF Remote Display	Integral 802.15.4 RF Modem for connectivity to Optional MSI-8000 RF Remote Display.
MSI-8000 RF Remote Display	100' (30 m) typical range line of sight. Uses 802.15.4, 2.4 GHz transceiver

Table 1-1. Specifications



The MSI-3460 scale has a safe mechanical overload of 200%, and an ultimate overload of 500%. Overloads greater than 500% may result in structural failure and dropped loads. Dropped loads may cause serious personal injury or death.

1.5 Features

- Designed to meet or exceed all U.S. and international standards.
- Typically 50 hours of weighing time utilizing automatic sleep mode.
- Automatic power off conserves battery life by sensing no activity after 15, 30, 45 or 60 minutes, determined by operator, and turns off power.
- Automatic Sleep Mode preserves battery life by dimming the LED display after 5, 15, or 30 minutes of no activity.
- Rugged construction throughout. Buttons are sealed and rated for over one million operations.
- Precise high resolution (2500 division standard and up to 10,000 possible) 24 bit A/D conversion coupled with advanced RISC micro controller provides world class features and accuracy.
- Five large, 1.5 inch (38 mm) LED digits for clear weight readings from a distance.
- Easy to maintain: full digital calibration assures reliable, repeatable measurements. Can be calibrated without test weights using MSI R-Cal technology.
- Selectable for kg/lb unless prohibited by LFT regulations.
- Automatic or manual weight totalization for loading operations.
- Easily customized for special applications.
- Hi speed PEAK mode for wire and rope stress analysis.
- Three setpoints can be set for any in-range weight for operator alerts or process control.
- ScaleCore technology provides quick and easy software updates and calibration/setup backup.
- Two service counters ensure load train safety by warning the user to perform a load train safety check when the lift count gets high or the scale has been overloaded repeatedly.

1.6 Options

Options which you may have ordered with your Challenger 3 may include the following:

- RF remote controller
- RF modem for connectivity to MSI-8000 RF Remote Display
- MSI-8000 RF Display
- 85-265 VAC input power.
- Audible alarm (triggered by setpoint 1)

1.7 Unpacking

When unpacking the scale from the shipping container, ensure that all assembly parts are accounted for. Check the scale for any visible damage and immediately report any damage to your shipper. It is advisable to use the original shipping container when shipping or transporting the Challenger 3.

1.8 Assembly

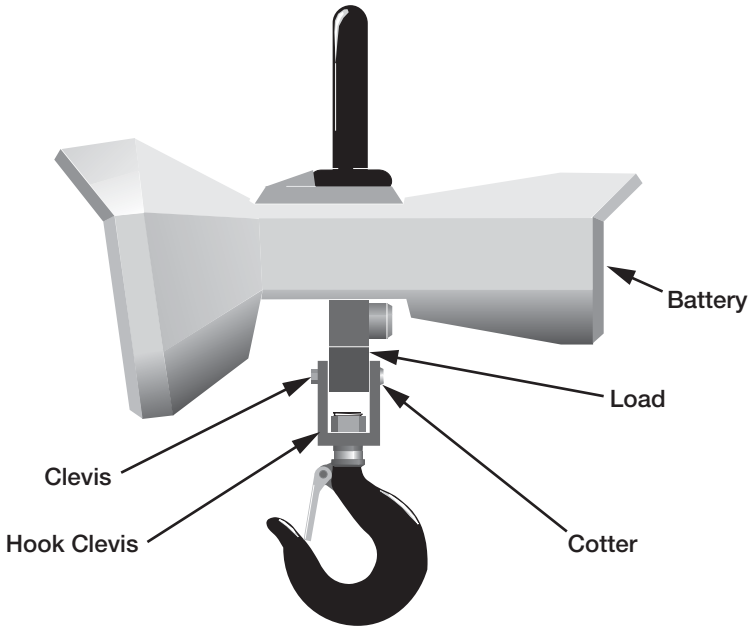

Figure 1-2. MSI-3460 Assembly

1. Slide hook clevis over load cell with open end of hook toward front of scale.
2. Align holes of clevis and load cell.
3. Slide the clevis pin through the clevis and load cell holes.
4. Lock clevis pin in place with cotter pin. Bend cotter pin.



WARNING

Scale will be unsafe for use if clevis pin is not properly secured with the cotter pin.

5. Slide battery pack into battery compartment. The battery will automatically engage with its connectors.
6. Secure battery pack by turning the two locking fasteners on access door clockwise 1/4 turn.
7. The scale is now ready for use.

1.9 Battery Pack

The *MSI-3460* is powered by a six volt rechargeable battery. The battery door is part of the battery pack.

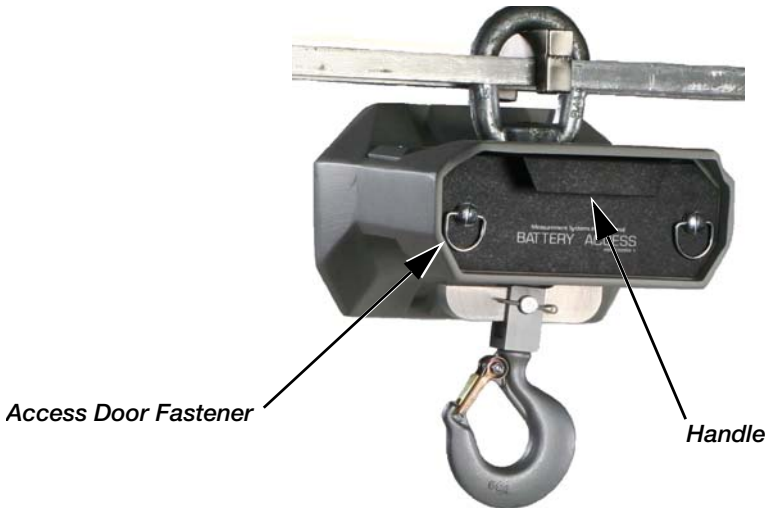

Figure 1-3. Battery Pack Removal

To Remove the Battery Pack

1. Turn the two fasteners on the access door counter clockwise 1/4 turn,
2. Grasp handle and pull the battery pack straight out. The battery will automatically disengage from its connectors.

The battery will operate for up to 100 hours (depending on LED brightness setting) before requiring recharging. In order to conserve battery life, the scale includes an automatic power off mode which senses operational status for no activity after 15, 30, 45, or 60 minutes, and turns the scale off. An additional battery saving feature is the automatic sleep mode. This feature preserves battery life by dimming the display after 5, 15, or 30 minutes of no scale activity. Charging time for a completely discharged battery is up to eight hours. A spare battery pack is recommended to keep the Challenger 3 in continuous operation.



Note

To obtain maximum service life from your batteries they should be stored between -4°F and 122°F (-20°C and +50°C). Stored batteries should be recharged every three months. Battery is fully charged when the status indicator is flashing.

1.10 Battery Charger

1. Remove the battery from the scale.
2. Plug battery charger into an AC power receptacle. The input voltage is universal from 115/230 VAC, 50/60 Hz. If the power input plug doesn't match, contact MSI for information on international plugs.
3. Slide the battery charger connector plate over the top of the battery until the battery terminals mate with the charger connectors, as seen through the two observation holes.
4. Approximately six to eight hours is required to recharge a fully discharged battery. If a battery was deep discharged, more time might be required, but the *MSI-3460* prevents deep discharging. Partially discharged batteries will finish the charge faster.

The charger is a three stage float charger that can be left on the battery indefinitely. It has a dual color LED to indicate the charging state: RED- fast charge mode. GREEN-charged or float charge.



Figure 1-4. Battery Charger



Note

To obtain maximum service life from your batteries, the manufacturer suggests recharging after each 20 hours of use. Continuous deep discharging will reduce maximum battery life cycle estimated at 2000 cycles.

A second battery is recommended to enable you to use your scale continuously. Keep one on the charger while the other is in service.

2.0 Operation

2.1 Power

To turn on the power.

1. Press  , the following will display in order:
 - LED will light all segments at full brightness as a display test.
 - Display brightness will change to the setting determined in the display menu.
 - Software version number will display.
 - The *MSI-3460* is ready for use.

2.2 Zero

Sets the zero reading of the Scale. Use the **ZERO** key to take out small deviations in zero when the scale is unloaded. See “TARE” for zeroing (Taring) package or pallet weights.

1. Press 



Note *The weight reading must be stable within the motion window for the zero function to work.*

The scale digits display 0 (or 0.0 or 0.00, etc).

The backup memory in the MSI-3460 stores the zero reading, and can restore it even if the power fails.

Rules for Use:

- Works in GROSS mode or NET mode. Zeroing while in net mode will zero the gross weight causing the display to show the negative tare value.
- The scale must be stable within the motion window. The scale will not zero if the motion detect annunciator is on. The scale will “remember” that it has a zero request for two seconds. If motion clears in that time, the scale will zero.
- The scale will accept a zero setting over the full range of the scale (NTEP and other Legal for Trade models may have a limited zero range). Zero settings above 4% of full scale will subtract from the overall capacity of the scale. For example if you zero out 100 lb. on a 1000 lb. scale the overall capacity of the scale will reduce to 900 lb. plus the allowed over-range amount.

2.3 Tare

Tare is typically used to zero out a known weight such as a packing container or pallet and display the load in NET weight. A tare value is entered by pressing the **TARE** key. The TARE function in the *MSI-3460* is defined as a Tare-In, Tare-Out operation. The first press of the **TARE** key stores the current weight as a tare value and then the scale subtracts the tare value from the gross weight and changes the display to NET mode. The next press of the **TARE** key will clear the tare value and revert the display to GROSS mode.

To view the gross weight without clearing the tare value, program the **USER** key to the function “NET/GROSS.” The RF remote control has a Net/Gross permanently available.

To Tare and Display the Net Weight

1. Press  TARE



Note *The weight reading must be stable within the motion window for the tare function to work.*

The scale digits display 0 (or 0.0 or 0.00, etc) and the weight mode changes to NET.

The backup memory in the MSI-3460 stores the tare reading and can restore it even if power fails.

To Clear the Tare and revert to Gross Weight

1. Press  . The net annunciator will turn off and the gross annunciator will turn on.

Tare - Rules for Use:

- Only positive gross weight readings can be tared.
- The motion annunciator must be off. The weight reading must be stable.
- Setting or changing the tare has no effect on the Gross zero setting.
- Taring will reduce the apparent over range of the scale. For example, taring a 100 lb container on a 1000 lb scale, the scale will overload at a net weight of 900 lb (1000-100) plus any additional allowed overload (usually ~4% or 9d).
- The scale stores the tare value in non-volatile memory and is restored when power is cycled.

3.0 User Defined Function Keys

The following function descriptions are for optional user defined functions that are programmed on the front panel USER key or the two function keys (F1 & F2) on the RF remote control. The functions TOTAL, VIEW TOTAL, and NET/GROSS are available full time on the RF remote control. To enable any of the USER key functions, you must set up the USER keys following the procedures in Section 4.0.

TEST

The TEST function provides an LED test that lights all LEDs at once, next the SW Model number followed by the software version number, the battery voltage, and then performs a display test that counts from 00000 to 99999. Other internal tests are performed and if any test fails, an error code will display. See Section 8.0 for a description of all error codes. Press the **USER** key again within two seconds to enable a single step through all the test functions. In the single step mode, use the **USER** key to scroll through the available test functions and the **TARE** key to start or display the individual tests. Use the **ZERO** key to exit individual tests. Use the **ZERO** key to exit entirely from the TEST function.

CH3.5n – Challenger 3 software version number: Press **TARE** to see the software version.

bAtt – Battery voltage: Press **TARE** to see the battery voltage.

d.tEst – Display test: Press **TARE** to have the display count up from 00000 to 99999.

C-CAL – Cal constant display: Press **TARE** to view the C-CAL value.

TOTAL



The total mode must be programmed from the setup menus before the USER key will function.

For accumulation of multiple weighments. The accumulator always uses the displayed weight, so GROSS and NET readings can be added into the same TOTAL. There are four modes of totalizing: manual and three auto modes. The manual mode requires the TOTAL button be pressed with the weight on the scale. The weight will be added to the previously accumulated value. This assures that a weight on the scale is only added to the total once. Both the manual and three auto total modes require that the weight on the scale return below 0.5% (relative to full scale) of GROSS ZERO or NET ZERO before the next weighment can be added. Applied weight must be $\geq 1\%$ of full scale above GROSS ZERO or NET ZERO before it can be totaled.

MANUAL TOTAL

The **USER** key under the MANUAL TOTAL mode functions in this manner:

Weight is > 1% of Capacity and has not been totaled – Pressing the **USER** key will add the current weight to the TOTAL weight. The ACK LEDs blink to indicate the weight was accepted. The TOTAL annunciator lights and the total weight is displayed for five seconds and then the number of samples is displayed for two seconds.

Current Weight has been totaled – Pressing the **USER** key will display the total weight for five seconds (View Total) without changing the total value. The TOTAL annunciator will light during the TOTAL weight display. After five seconds of total weight display, the number of samples is displayed for two seconds.

Weight is <1% of Capacity – The **USER** key functions as “View Total” only and functions as view total until the 1% threshold is exceeded to allow the next addition to the total value.

AUTO TOTAL

The **USER** key under the AUTO TOTAL mode functions as Auto Total On / Auto Total Off.

The auto mode has three variations which are programmed in the SETUP menu:

- **AutoLoad** – Any settled weight above the ‘Rise above’ threshold will be automatically totaled. Then the scale must fall below the ‘Drop below’ threshold before another total is allowed.
- **AutoNorm** – This mode takes the last settled weight to auto total with. The total occurs only once the scale goes below the threshold. This allows the load to be adjusted without a total occurring. Once the load is removed, the scale uses the last settled reading for total.
- **AutoHigh** – Similar to the AutoNorm mode except the scale uses the highest settled reading. Useful for loads that can’t be removed all at once.

View Total

The function key activates the total weight display followed by the number of samples. While the display is showing the total, total is cleared by pressing **ZERO**.

Net / Gross

Switches the display between net and gross modes. Net weight is defined as gross weight minus a tare weight.

To switch between net mode and gross mode:

1. Press the **USER** key (Setup to the Net/Gross function).
2. The **NET/GROSS** key will only function if a tare value has been established.
3. Switching back to gross mode from net mode will not clear the tare value. This allows the operator to use the gross mode temporarily without having to re-establish the tare value. Only clearing the tare or setting a new tare will change the tare value held before switching into gross mode.

OIML LFT units only: The NET/GROSS key is temporary action only. The gross weight is displayed for two seconds and then the display returns to the net mode. The only way to return to permanent gross readings is to clear the tare (see clear tare procedure).

PRINT

If print option is installed this menu choice will appear. The setup of the print function is covered in the option manual.

LEARN

Used for programming the RF remote control. This function is detailed in Section 6.0.

PEAK HOLD

Peak hold will only update the display when a higher peak weight reading is established. The peak hold function uses a high speed mode of the A/D converter allowing it to capture transient weights at a far higher rate than typical scales. Peak hold is cleared and re-enabled with the USER key.

PEAK HOLD is not available on NTEP or OIML certified Legal for Trade scales.

UNIT

The function key will switch the weight units between pounds and kilograms.

UNIT switching is not available on OIML certified Legal for Trade scales.

4.0 Configuration

4.1 Menu Map

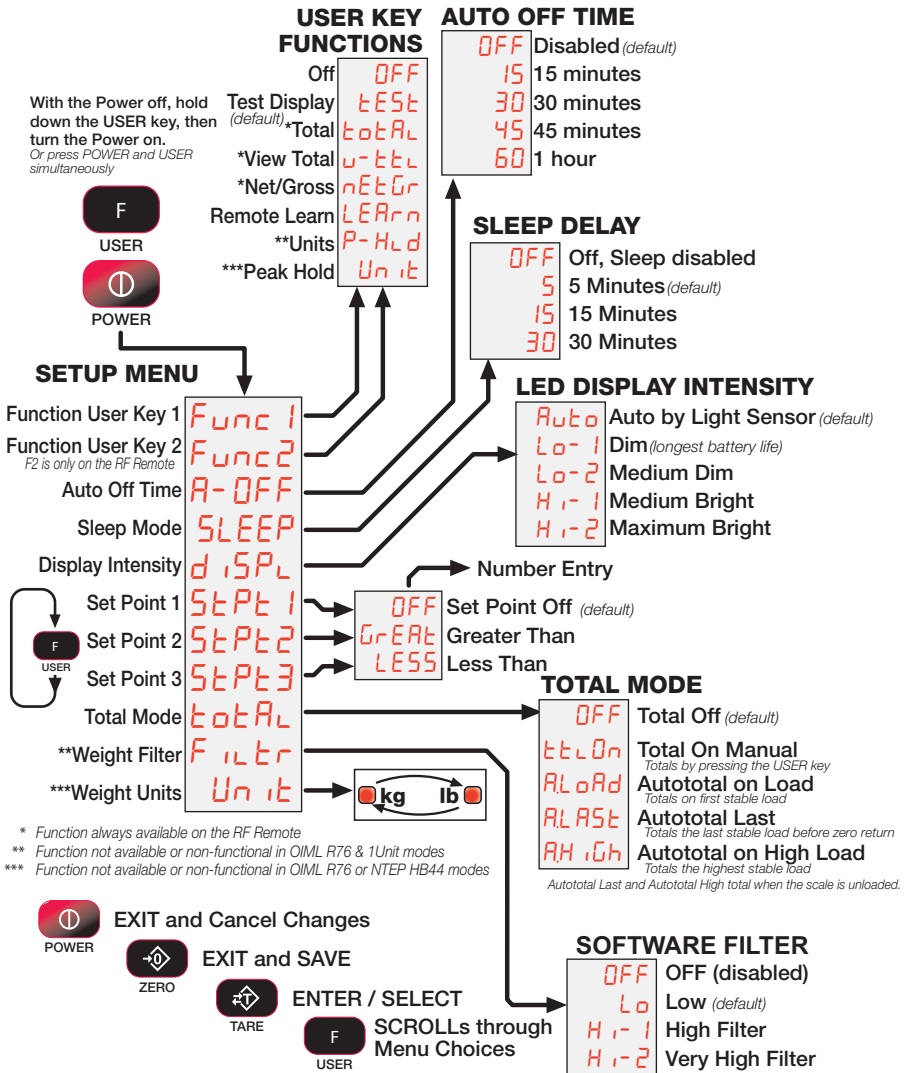

Figure 4-1. Setup Menu Map

4.2 Function Keys

The MSI-3460 has one user definable function key on the front panel, and an additional user definable function key on the RF remote control that can be programmed to any of several functions.

Function Key Setup

- 1) With the 3460 off, press and hold the **USER** key, then press the **POWER** key.
*...or while the 3460 is on, press **USER** and **POWER** simultaneously.*
- 2) The first item of the Setup Menu is **Func1**.
- 3) To set up the User key press **TARE**. The current User key function is displayed.
- 4) Select the User key function by scrolling through the choices with the **USER** key. See the list of available functions on the Setup Menu Map.
This procedure scrolls through all available choices for illustration purposes only.
In this example, we'll set F1 to the TEST function.
- 5) When the desired User Key function is displayed, press **TARE**. The next item in the Setup Menu appears.
- 6) Either press **ZERO** to exit Setup and store all changes, or continue to another Setup Menu item using the **USER** Key.

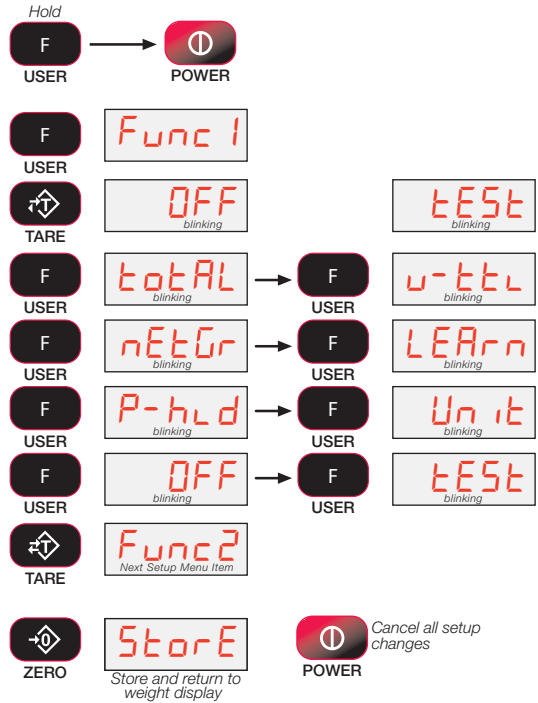

Figure 4-2. Function Keys

4.3 Auto- Off

The Auto-Off feature, when enabled, prolongs the battery life of the scale by turning POWER off when the scale is not in use. Any time a button is depressed (any button), or the detected weight is in motion exceeding 5 or 10d, the time limit is reset. Therefore, the scale will stay on indefinitely if the weight is changing or any button is pressed at least once. With Auto-Off disabled, the scale will remain on; only pressing POWER will turn it off (or if the battery is depleted).

Auto-Off Setup

- 1) With the 3460 off, press and hold the **USER** key, then press the **POWER** key.
*...or while the 3460 is on, press **USER** and **POWER** simultaneously.*
- 2) The first item of the Setup Menu is **Func1**. Scroll to "A-OFF" with the **USER** key.
- 3) To set up the A-Off timing, press **TARE**. The current Auto-Off time is displayed.
- 4) Select the Auto Off time by scrolling through the choices with the **USER** key.
In this example, we'll set 60 minutes as the Auto-Off time.
- 5) When the desired time is displayed, press **TARE**. The next item in the Setup Menu appears.
- 6) Either press **ZERO** to exit Setup and store all changes, or continue to another Setup Menu item using the **USER** key.

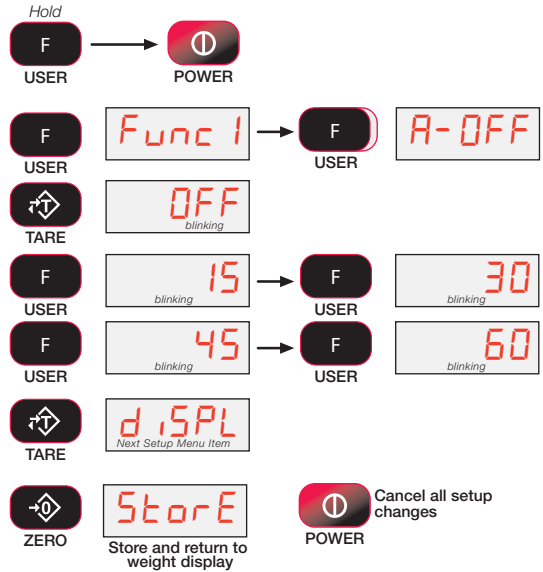

Figure 4-3. Auto-Off

4.4 Sleep

The SLEEP feature reduces power consumption by automatically turning off the display during periods of inactivity. When in the sleep mode, the red acknowledge annunciator blinks at a one second rate. To wake up either a button must be pushed (front panel or RF remote), or the weight must change by 5d or more.



Note *SLEEP must be set to less time than the Auto-Off timer. For example, set SLEEP to five minutes and Auto-Off to 30 minutes.*

Sleep Setup

- 1) With the 3460 off, press and hold the **USER** key, then press the **POWER** key.
*...or while the 3460 is on, press **USER** and **POWER** simultaneously.*
- 2) The first item of the Setup Menu is **Func1**. Scroll to **SLEEP** with the **USER** key.
- 3) To set up the sleep timing, press **TARE**. The current Auto-Off time is displayed.
- 4) Select the sleep start time by scrolling through the choices with the **USER** key.
In this example, we'll set 30 minutes as the sleep start time.
- 5) When the desired time is displayed, press **TARE**. The next item in the Setup Menu appears.
- 6) Either press **ZERO** to exit setup and store all changes, or continue to another Setup Menu item using the **USER** key.

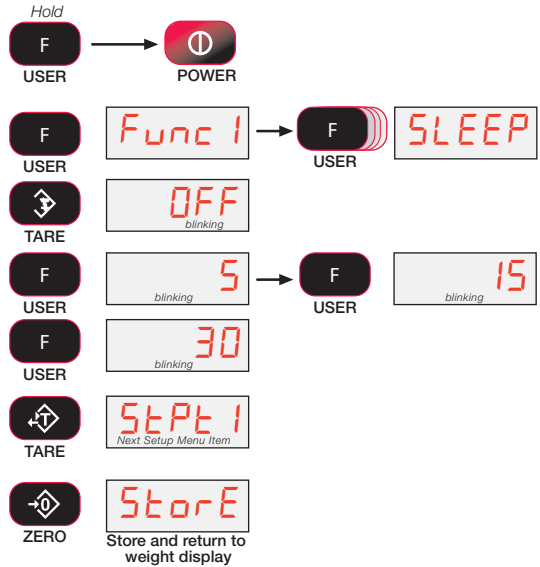

Figure 4-4. Sleep Setup

4.5 Display Brightness

The display setup menu is used to set the display brightness. There are four fixed brightness settings, and one automatic light sensing brightness setting. The auto setting will automatically detect the ambient light and adjust the brightness of the display accordingly. Bright light will cause the display to be at the brightest setting. The display brightness will reduce as ambient light reduces. The four fixed brightness settings, LO-1, LO-2, HI-1, and HI-2 change the average current in the display. Lower settings increase battery life.

Display Brightness Setup

- 1) With the 3460 off, press and hold the **USER** key, then press the **POWER** key.
*...or while the 3460 is on, press **USER** and **POWER** simultaneously.*
- 2) The first item of the Setup Menu is **Func1**. Scroll to **diSPL** with the **USER** key.
- 3) To set up the display brightness, press **TARE**. The current brightness setting is displayed.
- 4) Select the display brightness by scrolling through the choices with the **USER** key. The menu brightness changes as you scroll through the choices.
*In this example, we'll set the brightness to the **AUTO**, light sensing brightness control.*
- 5) When the desired display brightness setting is displayed, press **TARE**. The next item in the Setup Menu appears.
- 6) Either press **ZERO** to exit Setup and store all changes, or continue to another Setup Menu item using the **USER** key.

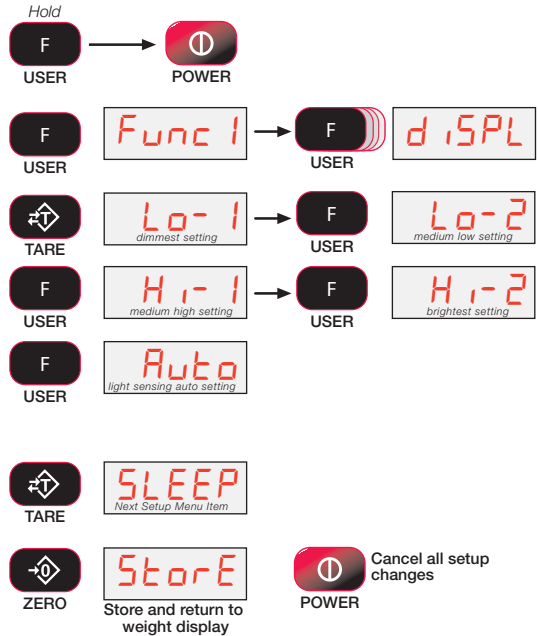

Figure 4-5. Display Brightness

4.6 Set Points

The *MSI-3460* supports three setpoints. Common uses of setpoints are for warnings or process control. The *MSI-3460* comes standard with LED outputs for a triggered set point. Setpoint 1 and 2 are Blue LEDs and Setpoint 3 is Red. The *MSI-3460* has an audible output option that is triggered by Setpoint 1. Contact MSI for other setpoint output options.

Setpoint Setup

- 1) With the 3460 Off, press and hold the **USER** key, then press the **POWER** key.
*...or while the 3460 is on, press **USER** and **POWER** simultaneously.*
- 2) Scroll through the setup menu choices by pressing the **USER** key. Stop when the LED displays **StPt1**, **StPt2**, or **StPt3**.
- 3) When the desired setpoint is displayed, press **TARE**. The display blinks **OFF**, or if previously programmed, the last set mode.
- 4) Select the setpoint mode by scrolling through the choices with the **USER** key. **GrEAt** (greater than) indicates the setpoint will trigger when the weight exceeds the value. **LESS** (less than) will trigger the setpoint when the weight is less than the value. *This example scrolled through all available choices for illustration purposes only.*
- 5) When the desired setpoint mode is displayed, press **TARE**
- 6) Next select the type of weight value the setpoint is assigned to. Use the **USER** key to scroll through the choices.

This example scrolled through all available choices for illustration purposes only. In this example, we'll enter gross as a weight mode because we are going to use the setpoint as a safety warning.
- 7) When the desired weight mode is shown, push **TARE**. Next the current setpoint value is displayed. *If there was a previous value, it is displayed. If no value has been entered, a zero will appear. To keep the displayed value, press **ZERO***

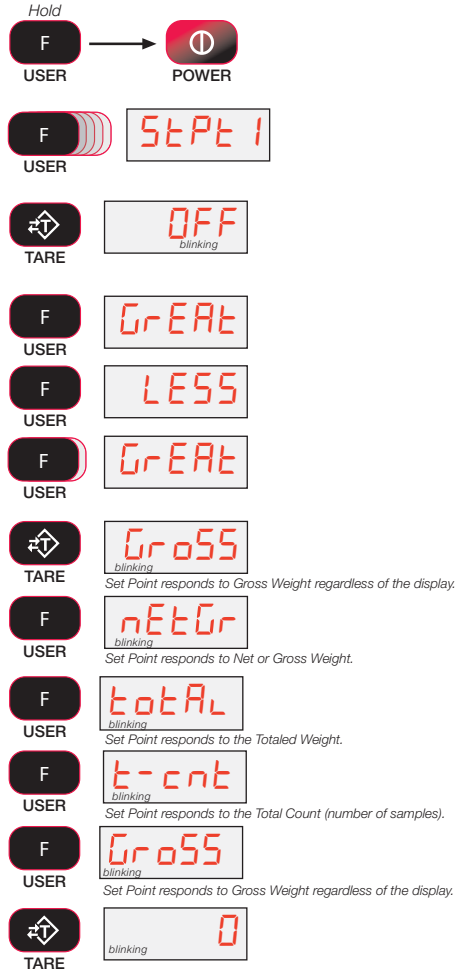

Figure 4-6. Set Point Setup

- 8) Press the **USER** key. The first digit blinks at zero. Use the **USER** key to scroll through the numbers. When the desired number is shown, push **TARE**.

In this example, we'll enter 240 as a setpoint value.

*To enter a decimal point, push **POWER** while the digit is blinking.*

*Error Correction: If you input a wrong value, press **ZERO** to step back one digit and change the digit with the **USER** key.*

- 9) When the desired number is shown, push **TARE** a second time to set the value. The next setup menu item is displayed.

- 10) Either press **ZERO** to exit setup and store all changes, or continue to another setup menu item using the **USER** key.

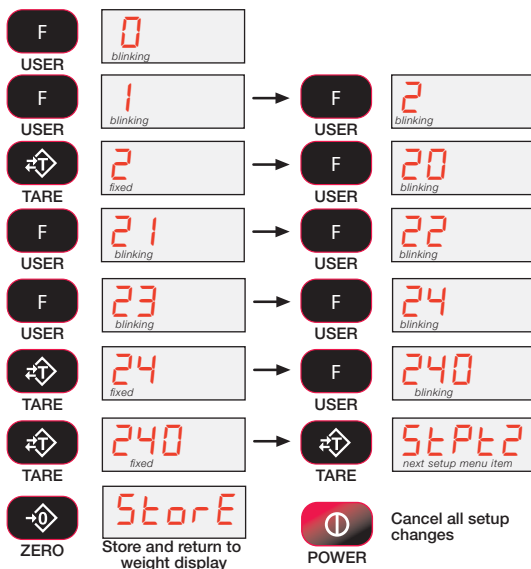

Figure 4-7. Set Point Setup Continued

4.7 Total Mode

The MSI-3460 can keep track of all weighments using the total feature. Either manual total, which totals by pushing a configured USER key on the front panel or the RF remote, or auto-total, which can be used to automatically add up each weighment. See the total mode descriptions for details on the various total modes. To use manual total, you must also program a user key. Auto total modes do not need a user key, but if a user key is setup for total, then it will function as a total on / total off.

Total Mode Setup

- 1) With the 3460 off, press and hold the **USER** key, then press the **POWER** key.
*...or while the 3460 is on, press **USER** and **POWER** simultaneously.*
- 2) The first item of the Setup Menu is **Func1**. Scroll to **total** with the **USER** key.
- 3) To setup the Total Mode, press **TARE**. The current Total Mode setting is displayed.
- 4) Select the Total Mode by scrolling through the choices with the **USER** key.
In this example, we'll set the Total Mode to the Auto-High mode. The Auto High mode uses the highest stable reading as the total value, and totals when the load is removed.
- 5) When the desired Total Mode setting is displayed, press **TARE**. The next item in the Setup Menu appears.
- 6) Either press **ZERO** to exit Setup and store all changes, or continue to another Setup Menu item using the **USER** Key.

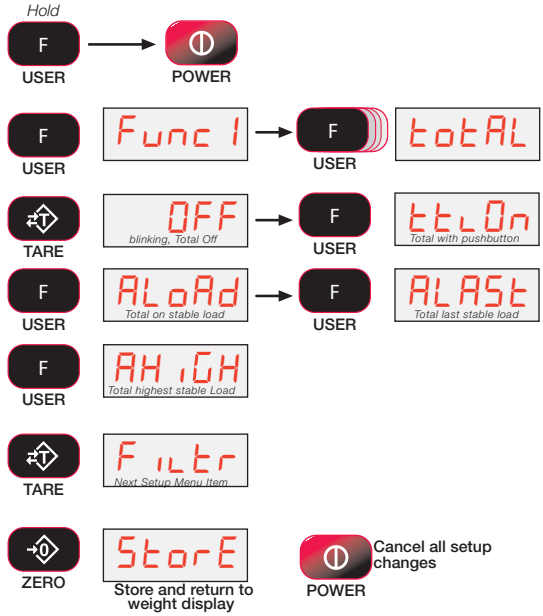

4.8 Units

Units can be changed in two ways:

- Program a user function key to units
- Change the units with the setup menu with the following procedure



Note OIML LFT scales do not allow units to be changed.

Units Setup

- 1) With the 3460 off, press and hold the **USER** key, then press the **POWER** key.
...or while the 3460 is on, press **USER** and **POWER** simultaneously.
- 2) The first item of the setup menu is **Func1**. Scroll to **Unit** with the **USER** key.
- 3) To setup the weight units, press **TARE**. The display will blink **Unit**.
- 4) Change the weight units by pressing the **USER** key. The unit is indicated by the annunciators.
- 5) When the desired unit setting is annunciator, press **TARE**. The next item in the setup Menu appears.
- 6) Either press **ZERO** to exit setup and store all changes, or continue to another setup menu item using the **USER** Key.

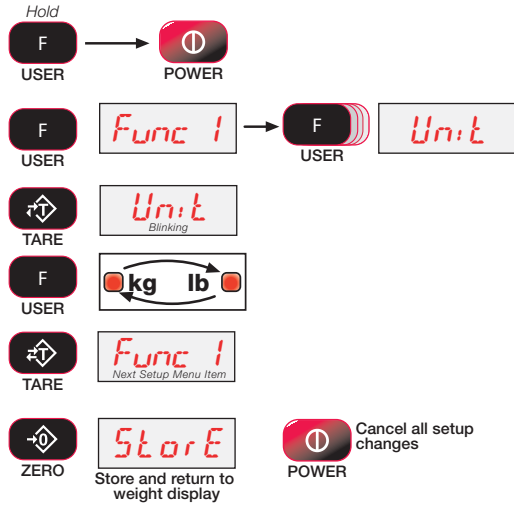

Figure 4-8. Units Setup

4.9 Filter Setup

Changing the filter settings allows the scale to adjust to situations where there is a lot of movement in the structure. If the reading is not stable, it can often be improved by increasing the filter setting. Settling time will be longer as the filter setting is increased. However, the *MSI-3460* employs algorithms that speed up large weight changes while still controlling vibration even with high filter settings.

Filter Setup

- 1) With the 3460 off, press and hold the **USER** key, then press the **POWER** key.
...or while the 3460 is on, press **USER** and **POWER** simultaneously.
- 2) The first item of the Setup Menu is **Func 1**. Scroll to **Filtr** with the **USER** key.
- 3) To setup the filter, press **TARE**. The display will blink the current filter setting.
- 4) Change the filter setting by pressing the **USER** key.
There are four available filter settings. Not all choices are shown in this example.
- 5) When the desired filter setting is displayed, press **TARE**. The next item in the setup menu appears.
- 6) Either press **ZERO** to exit setup and store all changes, or continue to another setup menu item using the **USER** key.

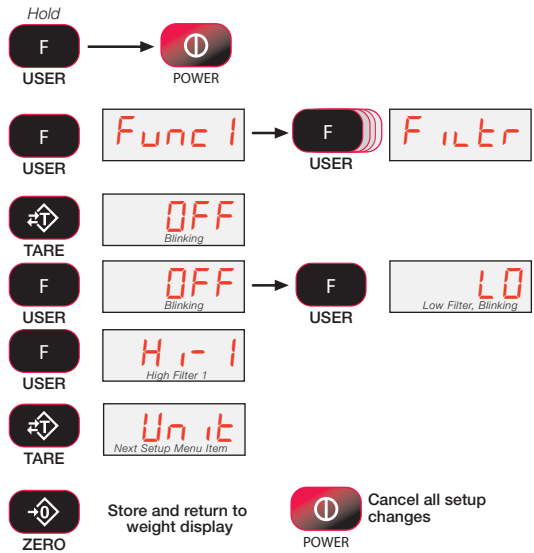

Figure 4-9. Filter Setup Menu Map

5.0 Calibration

The *MSI-3460* is calibrated using standard weights. It is required that the weight used is at least 10% of full capacity in order to achieve rated accuracy. For example, use at least a 500 kg test weight to calibrate a 5000 kg capacity scale. Although a single span point is usually adequate for rated accuracy, the *MSI-3460* supports Multi-Point calibration with up to 4 span points + Zero.

When adequate test weights are not available, the *MSI-3460* can be calibrated using a calculated constant calibration which is referred to as C-Cal. To use C-Cal, a previously generated C-Cal number must be known. MSI supplies replacement load cells for the *MSI-3460* with the C-Cal value stamped on the serial number label.

There are three types of calibration:

- **Standard Calibration** – is used for maintenance and routine calibration.
- **Initial Calibration** – is used to set up both the capacity and resolution (d) of the scale. It differs from standard calibration only in the initial steps. Initial calibration is performed after a calibration reset which completely erases the calibration and setup memory.
- **C-Cal** – If the last calculated C-Cal values is known, the scale can be calibrated without weights.

Standard Calibration Procedure

- 1) Remove the seal screw. With a small screwdriver press the Cal Switch behind the seal screw.
The CAL Setup Menu appears.
- 2) Press **TARE** to Start the Calibration Procedure.
- 3) The display reads **UnLd** (unload) indicating you should remove all weight from the hook.
- 4) Ensure the 3460 is motionless, then press **TARE**. The 3460 sets the zero calibration point. Wait while the display is blinking.
- 5) If the zero is in range, the scale will display **PASS**. Then **LoAd1** is displayed.
- 6) Load the scale with a precision test weight. *For single span point calibrations a test weight of 20% of capacity or more is recommended.*
- 7) Press **TARE**. The 3460 flashes the capacity. If you are loading the scale with the capacity weight, skip to step 10.



Figure 5-1. Standard Calibration Procedure

8) To enter a calibration weight other than capacity, press **USER**. The display far left digit will flash zero indicating that a number should be entered.



Error Correction: If you input a wrong value, press ZERO to step back one digit and reenter.

9) Press the **USER** key to scroll the number and the **TARE** key to enter each digit of the calibration weight.
In this example, we'll enter 2500 kg on a 5000 kg capacity scale. Do not push the TARE key two times in a row until the entire number is showing.
To add a decimal point, push the POWER key while the number is blinking.

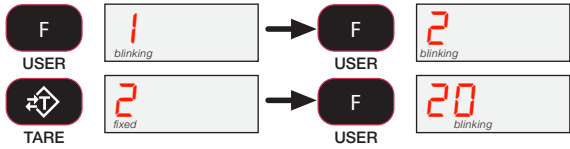

10) When the entire value of the test weight is displayed and the weight and scale are stable, press **TARE** to finish off the weight entry. If the resultant cal value is within limits, the display will read **PASS** briefly.

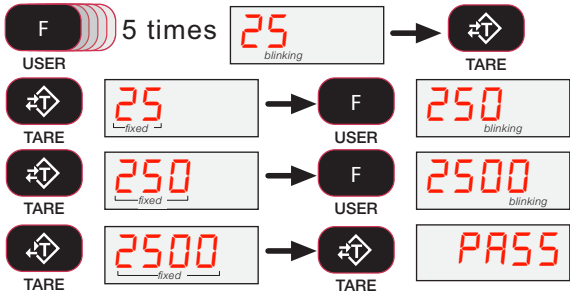

11) The display now reads **Load2**. The 3460 allows multipoint calibration. If more cal points are desired (up to 3 additional) press **TARE**. If a single point cal is all that's needed, press **ZERO** and jump to step 15.

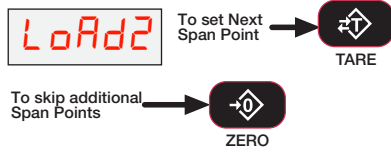

12) Load the scale with the next test weight. The display offers the reading that will occur without adjusting the value. If the weight value shown is acceptable push **TARE** and skip to step 14. If the calibrated value needs adjusting, go to step 13.



You can cancel calibration by pressing Power and the scale will reset to the previous calibration constants.

Test weights can be any in-capacity weight, the order is not important. The 3460 supports 5-Point Cal, Zero and up to 4 span points.

13) Press the **USER** key to scroll the number and the **TARE** key to enter each digit of the calibration weight value. When the entire calibration weight is displayed, push **TARE** a second time to finalize the calibration span point. If the resultant cal value is within limits, the display will read "PASS" briefly.

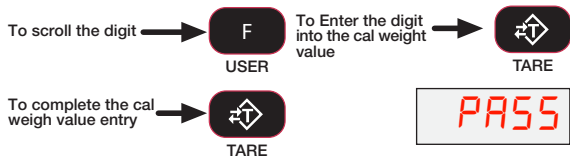

Figure 5-2. Standard Calibration Procedure, Continued.

- 14) The display now reads **LoAd3** or **LoAd4**. Repeat steps 12 and 13 for additional span points press **TARE** or press **ZERO** if you are finished.

After LoAd4 has passed, the 3460 will automatically advance to the next step.

- 15) The display shows **CAL'd** to indicate that the calibration was successful.

- 16) Press **TARE**. The display flashes **C-CAL** followed by the C-CAL number. Make a note of this number.

If the X1000 annunciator is lit, also make a note of that.

This number is used to calibrate when test weights are unavailable. C-CAL does not replicate multipoint calibrations.

- 17) Press **ZERO** to store the calibration constants, or after eight seconds, the calibration constants will automatically stored. After the store message is displayed, the scale goes to the next item on the cal menu, **SEtUP**.

- 18) Press **ZERO** to exit the Cal menus and start up the standard weight display. The 3460 is ready for use.

- 19) After ensuring the calibration is acceptable, replace the hex seal screw.

If the scale is being used as a Legal-for-Trade device, place a lead-wire seal through the cal screw over to the adjacent screw.

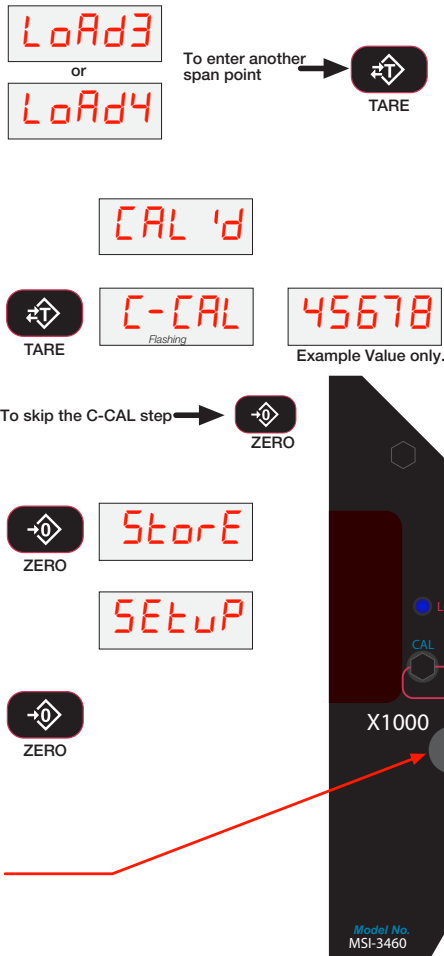

Figure 5-3. Standard Calibration Procedure, Continued.

5.1 Initial Calibration

Use this procedure only if the capacity and count by (d) needs to be modified. The initial steps of the initial calibration will totally erase user setups as well as any previous calibration.

Initial Calibration

Resetting Capacity and Countby (d)

- 1) Turn the 3460 off.
- 2) Remove the seal screw. With a small screwdriver press and hold the **CAL** switch behind the seal screw.
- 3) Still holding down the **CAL** switch, press the **POWER** switch.
- 4) The display blinks **rESEt**.
- 5) To reset all calibration constants and setup parameters, press **TARE**.
- 6) The 3460 requests a confirmation by displaying **SURE?**. To cancel the Reset press the **POWER** key.
- 7) To complete the reset, press **TARE**. The Calibrate menu appears. You must now recalibrate the system.
- 8) Press **TARE** to start the initial calibration procedure. The display shows **Unit**. You select the units you wish to calibrate in.
- 9) Press **TARE** to select the calibration unit.
- 10) Select the **USER** key to choose between lb and kg. When the desired unit is shown, press **TARE**.
- 11) Next, set the capacity in the selected units. Capacity must be set no higher than the load cell rated capacity.
- 12) Press **TARE** to enter the capacity setting screen. A capacity of 10000 is the initial value. If 10000 units is the desired capacity press **TARE** and skip to step 16.
- 13) To change the capacity, press **USER**.

Cal Switch



Remove Hex Seal Screw



Press Switch behind the hole with a small Screwdriver



TARE



TARE



TARE



TARE



USER



TARE



TARE



USER



Error Correction: If you input a wrong value, press **ZERO** to step back one digit and reenter.

To enter a decimal point, push **POWER** while the digit is blinking.

Figure 5-4. Initial Calibration

14) The first digit blinks. Use the **USER** key to scroll through the numbers. When the desired number is shown, push **TARE**.

In this example, we'll enter 2500 as a capacity.

Continue inputting the desired capacity using the **USER** key for scrolling the number and the **TARE** key to store the number.

15) Finalize the capacity value by pressing the **TARE** key on an unblinking display. In our example, once the number 2500 is fixed on the display, press **TARE** to store the capacity value.

16) Next the scale division size 'd' is set. Press **TARE** to begin. *In this example we'll set the 'd' to 2 units.*

17) Select the **USER** key to scroll through the recommended scale divisions. *The first 'd' offered is the standard division for the given capacity. Setting a 'd' size that results in total resolution higher than 1:5000 is not recommended for stability reasons.*

18) When the desired scale 'd' is displayed, press **TARE**. The **UnLd** display appears and the scale is ready for calibration. Follow the standard calibration procedure starting at step 3.

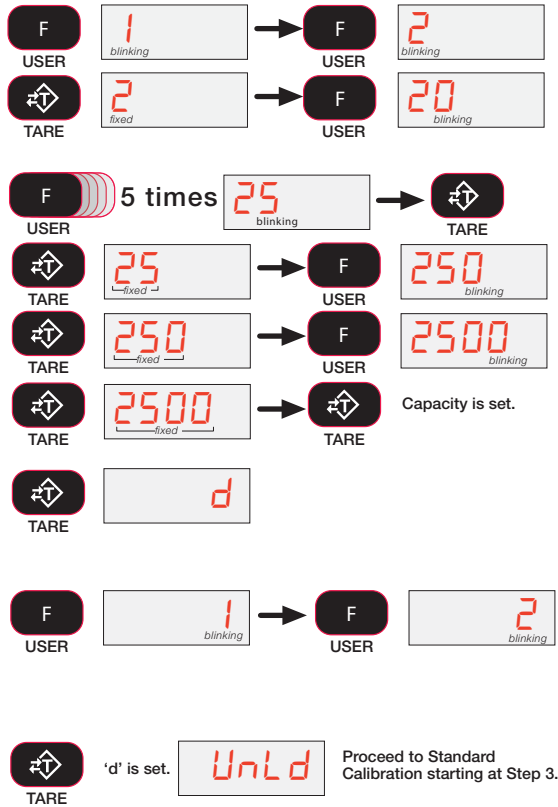

Figure 5-5. Initial Calibration, Continued

5.2 Guidelines for Capacity and Resolution

Crane scales are subject to forces that regular floor scales do not see. Many bridge cranes, hoist cranes, and mobile cranes lack rigidity and tend to bounce or swing when loads are lifted. For this reason, MSI recommends that resolution is kept in the 1:2000 to 1:3000 range. Some improvement in stability can be achieved by increasing the filtering. However, you should never program resolution that is far greater than you need. If the *MSI-3460* display is never stable, it is recommended that the resolution is reduced and/or filtering increased.

Due to LFT requirements and general scale design criteria, the weight must be stable for certain features to work: ZERO – weight must be stable to be zeroed. TARE – weight must be stable to be tared. TOTAL – weight must be stable to be added to the total registers. One way to improve the stability is to increase the filtering, at the risk of increasing settling time. The other is to increase the ‘d’ (reduce resolution). The third way is to increase the **motion window**. The *MSI-3460* defaults to $\pm 1d$ as a motion window. It can be changed at MSI to a higher value if desired. Often $\pm 3d$ is chosen for bridge cranes as these tend to have a lot of bounce to them. This of course carries an accuracy penalty adding $\pm 3d$ to the total accuracy of the scale if the zero or tare operation happens to capture the weight in a valley or peak.

Setting capacity is dictated primarily by the capability of the load cell. MSI supplies the *MSI-3460* in many capacities.

Never set the capacity of the scale higher than the rating of the load cell.

Due to excellent linearity of the MSI S-beam load cell, it is acceptable to set lower capacities to better match the crane the *MSI-3460* is used on. For example, if the hoist is rated for 9000 lb. you can use an MSI 10000 lb. MSI 3460 and reset the capacity to 9000 lb. so that the scale will indicate overload at 9000 lb. instead of 10000 lb. Derating as much as 50% of the capacity is usually acceptable, but the scale may be less stable if the ‘d’ is decreased.

The capacity of all *MSI-3460* systems is rated approximately 20% higher than the rated capacity in pounds. This is to allow the kg capacity to be exactly 1/2 the number of the pounds capacity.

5.3 C-Cal Calibration

When adequate test weights are not available, the *MSI-3460* can be calibrated using a programmed constant calibration which is referred to as C-Cal. To use C-Cal, a C-Cal number must be known from a previous calibration. MSI supplies replacement load cells for the *MSI-3460* with the C-Cal value stamped on the serial number label. When a calibration is performed with test weights, a new C-Cal is generated. C-Cal can be used when the electronics are replaced to get an approximate calibration that may be suitable for non Legal-for-Trade applications.



Important

The C-Cal number must be known prior to starting this procedure. For a MSI-3460 with its original load cell, MSI prints this number on the calibration record, the serial number tag, and on the calibration log found inside the battery compartment.

C-Calibration reduces slightly the absolute accuracy of the system if the electronics are replaced or a new load cell is installed, and is intended for non-critical use only. Legal-for-Trade installations require that the *MSI-3460* is calibrated using test weights. If a system was originally multi-point calibrated, the C-CAL calibration will erase the additional span points, as C-Cal is only a two point calibration (Zero and Span at 10% of capacity).

C-Cal Calibration Procedure

- 1) Remove the seal screw. With a small screwdriver press the cal switch behind the seal screw.

The CAL setup menu appears.

Cal Switch

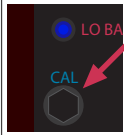

Remove Hex Seal Screw



Press Switch behind the hole with a small Screwdriver



- 2) Press the **USER** key to scroll to the C-Cal menu selection.



- 3) Press **TARE** to start the C-Cal procedure.

If this calibration is using a cleared 3460, the INITIAL CALIBRATION procedure will start here. You must set the cal unit, capacity, and count-before proceeding to step 4,



- 4) The display reads **UnLd** (unload) indicating you should remove all weight from the hook.



No weight on hook

- 5) Press **TARE**. The 3460 sets the zero calibration point.



Flashes Zero

- 6) If the zero is in range, the scale will display **PASS**.



- 7) Next the display reads **CCAL?** to ask that you look up the C-Cal value to be used.



Input C-Cal value

- 8) Press **TARE**. The 3460 is ready for numeric entry of the C-CAL value.



- 9) To enter an C-Cal value press **USER**. The display far left digit will flash zero indicating that a number should be entered.



Figure 5-6. C-Cal Calibration Procedure

- 10) Press the **USER** key to scroll the number and the **TARE** key to enter each digit of the C-Cal value.

In this example, we'll enter the C-Cal value of 2503. However, it should be noted that most C-CAL values are 5 digits.

Do not push the **TARE** key two times in a row until the entire number is entered. C-Cal's less than 4 digits will not be accepted. If the number is too small the display will read "LITTL" and go back to the "C-CAL" message.

Error Correction during number entry: If you input a wrong value, press **ZERO** to step back one digit and reenter.

For the rare C-CAL number that includes a decimal point and the X1000 annunciator, press the **POWER** key to enter the decimal point followed by an additional press of the **POWER** key to input the X1000 factor.

- 11) Once the entire number is entered (not blinking) press the **TARE** key to complete the entry of the C-Cal value.
- 12) If the Calibration was successful, the display will read **PASS** followed by **CAL'D**.
- 13) C-Cal is complete. Press **ZERO**. The next cal setup menu item appears.
- 14) Press **ZERO** to store the calibration and return to scale operation.

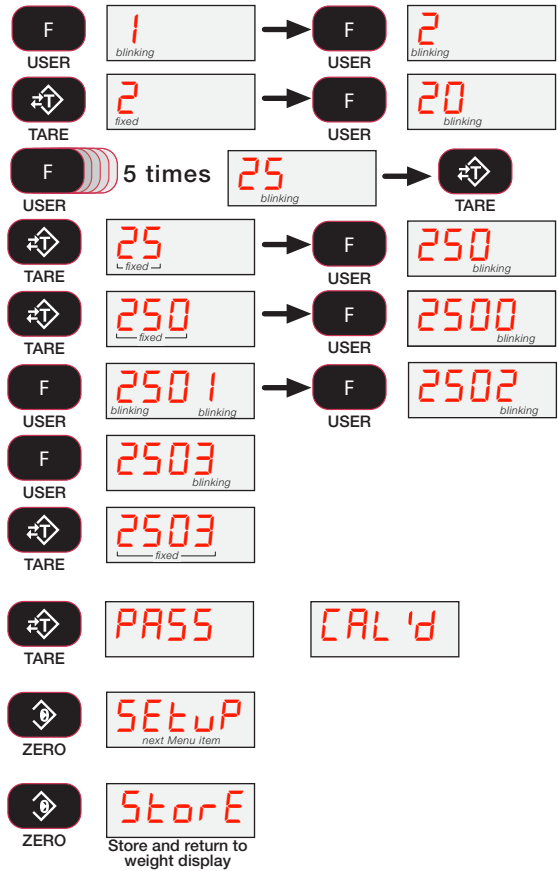

Figure 5-7. C-Cal Calibration Procedure, Continued.

5.4 Calibration Setup Menu

The calibration setup menu contains two items: standard and auto zero maintenance “Auto0.” In addition, more menus will appear that are transferred from the main setup menu when Legal for Trade settings are used.

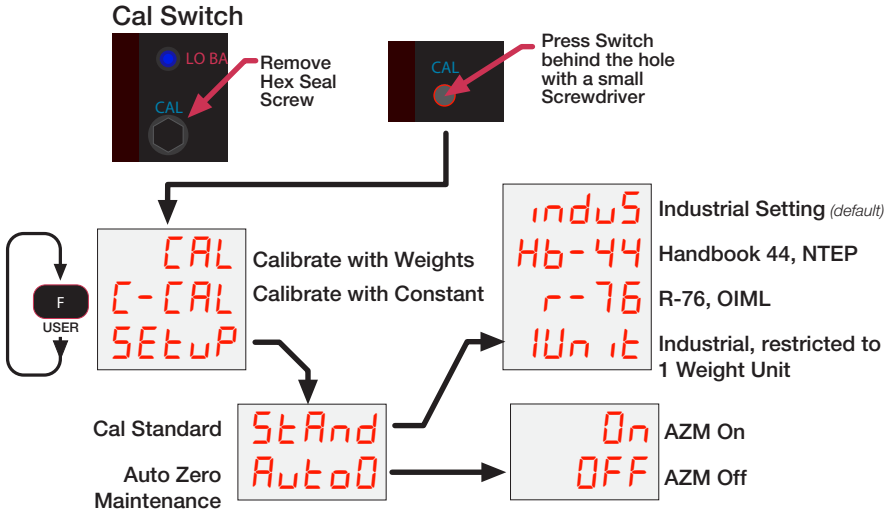

Figure 5-8. Calibration Setup

5.5 Standard

There are four selections in the standard menu.

1. Industrial (Indu5) - This is the most common setting for the *MSI-3460*. With the industrial standard, you have full range zero, access to units switching, filters, and peak hold.
2. Handbook 44 (Hb-44) - Sets the scale to enable only approved features per the NTEP HB-44 rules and regulations. Access is denied to peak hold, and the zero range may be limited. The filter menu is moved to the cal setup menu, so filters are only accessible through the cal seal.
3. R-76 (r-76) - Sets the scale to enable only approved features per OIML R-76. Only kg weight units are available. The zero range is limited to 5% (-2+3% relative to calibrate zero). Net/Gross function is temporary. Once net weight is established, pushing an F key set for Net/Gross will cause a maximum five second display of the gross weight. You must clear the tare to display gross weight constantly. Other metrological aspects are changed to meet R-76 requirements.
4. One Unit (1unit)-The one unit standard is exactly the same as industrial, except units switching is inhibited. This is useful for metric only countries. Another use of the one unit standard is to allow the scale to be calibrated in units other than lb or kg, since conversions are eliminated.

Contact MSI for more information on the standards settings.

Weight Standard Setup

If you are already in the Cal menu skip to step 2

- 1) Remove the seal screw. With a small screwdriver press the cal switch behind the seal screw. The CAL setup menu appears.
- 2) Press the **USER** key to scroll to **Setup**.
- 3) Press **TARE** to enter the cal setup menu.
- 4) Press **TARE** to enter the standard menu. The current standard setting is displayed.
- 5) Scroll to the desired standard pressing the **USER** key.
- 6) Press **TARE** to set the standard. The display goes to the next item in the CAL setup menu.
- 7) Either press **ZERO** twice to exit setup and store all changes, or continue to another setup menu item using the **USER** key.

Cal Switch











 F USER	CAL
 TARE	SEtUP
 TARE	StAnd
 F USER	indUS
 TARE	Un it
 TARE	Auto0 <small>Next Cal Setup Menu Item</small>
 ZERO	CAL <small>Calibrate Menu</small>
 ZERO	StorE <small>Store and return to weight display</small>

Figure 5-9. Weight Standard Setup

5.6 Auto Zero Maintenance

The MSI-3460 employs an autozeroing maintenance mechanism to adjust the zero reading to the center-of-zero (COZ). COZ is defined as the weight reading is within 1/4 'd' of zero. AZM continuously adjusts zero to maintain COZ. It is recommended that AZM is on to maintain the highest accuracy. However, there are circumstances when it should be turned off. This can happen when minor variations of weight occur while picking up scale attachments and the variations fall within the AZM capture window. The AZM capture window (usually 1 'd') and capture time (usually 8 seconds) can be adjusted by MSI to meet custom requirements. The settings of AZM are dictated in Legal for Trade standards and cannot be adjusted.

Auto Zero Maintenance Setup

If you are already in the Cal menu skip to step 2

- 1) Remove the seal screw. With a small screwdriver press the cal switch behind the seal screw. The CAL setup menu appears.
- 2) Press the **USER** key to scroll to **Setup**.
- 3) Press **TARE** to enter the cal setup menu.
- 4) Press **USER** to scroll to the **Auto0** menu.
- 5) Press **TARE** to enter the auto-zero menu. The current setting is displayed (blinking)
- 6) Change the setting between On or OFF pressing the **USER** key.
- 7) Press **TARE** to set the autozero. The display goes to the next item in the CAL setup menu.
- 8) Either press **ZERO** twice to exit setup and store all changes, or continue to another setup menu item using the **USER** Key.

Cal Switch



Remove Hex Seal Screw



Press Switch behind the hole with a small Screwdriver

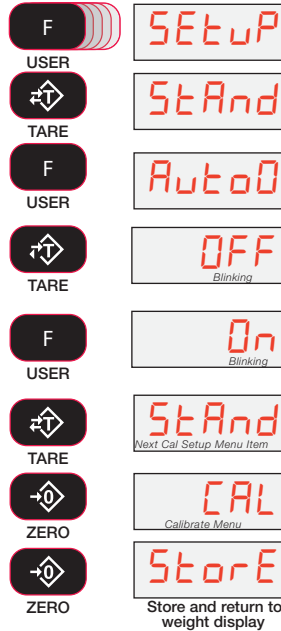

Figure 5-10. Auto Zero Maintenance

6.0 RF Remote Control Option

6.1 Description

The *MSI-3460* Series RF indicators can be equipped with an RF remote control (RFRC). The RFRC is a transmit only device that can be used to perform basic scale functions. The default switch functions can be changed in the function key menus and used for any *MSI-3460* programmable functions. Range will vary from 25' to 100' (50' typical) depending on room conditions and line of sight to the display. The remote receiving antenna is behind the red lens of the meter and best range will occur when the display is visible to the operator using the RFRC.

The RFRC provides the ability to turn the *MSI-3460* on remotely. The RFRC is available in three versions differing only in transmit frequency. The standard USA version operates at 418MHz. Available alternative frequencies are 315MHz and 433MHz primarily for use in countries other than the USA.

6.2 Functions

The default functions of the RF remote control duplicates the functions of the front panel keys on *MSI-3460* RF indicator. The POWER, ZERO, NET/GROSS, TARE, TOTAL, and VIEW TOTAL keys function identically. The TOTAL still must be enabled and configured in the *MSI-3460* before the total features will function properly.

The F1 key corresponds to the USER key on the *MSI-3460* front panel. The F2 key is unique to the remote and the function is set using the Func2 setup menu.

When a successful transmission is achieved, the ACK blue light will illuminate on the *MSI-3460* front panel.

6.3 Setting the Transmitter Address

The MSI RF remote control transmitter allows the selection of one of 16,777,216 (2^{24}) unique addresses. All transmitters are supplied set to the same address. To avoid contention with other units or to create unique relationships, the address should be changed. This is accomplished by using a paper clip or probe to press the CREATE button on the board through the hole in the back of the case.



1. Press the button and a LED will light up in the MODE_IND window, indicating that the address is being created. The address will be randomized for as long as the button is held down.
2. Release the button and the randomized address will be saved and the LED will begin flashing to indicate that the control permissions may now be set.
3. Press all the buttons one by one that the transmitter will have the authority to access. Press the CREATE button with the paper clip again or wait 17 seconds for it to time out. The address and control permissions are now set.



6.4 Setting the Receiver Address

Once the transmitter is setup, you must now program the corresponding *MSI-3460* to match.

1. Program the F1 key to “LEARN” (See the function key set up procedure). You can also remove the battery from the *MSI-3460*. Then the “LEARN” mode will start when the battery is plugged back in.
2. Start LEARN by pressing the USER key on the *MSI-3460* front panel (or plug in the *MSI-3460* battery).
3. Press each key on the transmitter that you plan to use. During the “LEARN” process the ACK annunciator will blink. You must complete all button pushes before it times out in 17 seconds.

Any *MSI-3460* can learn up to seven different remotes. However, never program multiple *MSI-3460*s to the same remote since they will all respond at the same time if they are in range.

6.4.1 Resetting the MSI-3460 RF Remote Receiver

Program the Func1 USER key to be Learn.

1. Press USER.
2. Press ZERO.
3. Reprogram the *MSI-3460* using the “Setting the Receiver Address” procedure.

6.5 Contention and Jamming Considerations

It is important to understand that only one transmitter at a time can be activated within a reception area. While the transmitted signal consists of encoded digital data, only one carrier of any frequency can occupy airspace without contention at any given time.

The RF remote control is a narrow band low power device and does not have the jamming immunity of the spread spectrum modem used by the *MSI-3460* to communicate to the remote display. Powerful sources of RF energy in the 418MHz region can jam the remote and prevent it from operating. In this circumstance, trying either of the two other available RF remote frequencies (433MHz and 315MHz) might solve the problem. Before ordering the RF remote control option, some effort to research RF devices used in the immediate area would be useful in avoiding jamming the control signals.

It is the end users responsibility to confirm that the chosen operating frequency is legal for use in your location.

In spite of the potential for jamming the remote control, the receiver is very immune from false reception due to the 24 bit encoding. Therefore no functions will be inadvertently executed.

6.6 Battery Replacement

The remote unit utilizes a CR-2032 button lithium cell. In normal use it will provide one to two years of operation. Access for replacement is accomplished by removing the battery access cover by pressing down firmly on the label area and sliding it off. Once the unit is open, remove the battery by sliding it from beneath the holder. Replace the cell with the same type while observing the polarity shown. Once the new battery is installed, both the transmitter and *MSI-3460* will have to learn new addresses. Follow both procedures for setting addresses.



6.7 RF Remote Control FCC Statement

Instruction to the User:

This equipment has been tested and found to comply with the limits for a Class B digital device, pursuant to Part 15 of the FCC rules. These limits are designed to provide reasonable protection against harmful interference in a residential installation. This equipment generates, uses and can radiate radio frequency energy and, if not installed and used in accordance with the instructions, may cause harmful interference to radio communications. However, there is no guarantee that interference will not occur in a particular installation. If this equipment does cause harmful interference to radio or television reception, which can be determined by turning the equipment off and on, the user is encouraged to try to correct the interference by one or more of the following measures: Reorient or relocate the receiving antenna. Increase the separation between the equipment and receiver. Connect the equipment into an outlet on a circuit different from that to which the receiver is connected. Consult the dealer or an experienced radio/TV technician for help.

This equipment has been certified to comply with the limits for a Class B computing device, pursuant to FCC rules. In order to maintain compliance with FCC regulations, shielded cables must be used with this equipment. Operation with non-approved equipment or unshielded cables is likely to result in interference to radio and TV reception. The user is cautioned that changes and modifications made to the equipment without the approval of manufacturer could void the user's authority to operate this equipment.

7.0 RF Remote Display Option

7.1 Introduction

The *MSI-3460* can communicate with peripheral devices using RS-232, 802.15.4, or 802.11/b,g,n WiFi. Only one communication type can exist at a time. Due to the difficulty of dangling RS-232 cables from a hanging crane scale, the RF options are more commonly used for gathering weight data. The RS-232 port located on the right side of the *MSI-3460* is useful for setup and calibration using a computer and MSI's SCCMP software. (SCCMP operation is detailed in the SCCMP User Guide). For RF operation, the *MSI-3460* uses an 802.15.4 transceivers to communicate between MSI's Model 8000 RF remote display. 802.15.4 operates in the 2.4GHz ISM band and does not require the end user to obtain a license. 802.15.4 can coexist with other 2.4GHz systems if caution is taken to isolate antennas at least 10 feet or 3 meters from the crane scales and *MSI-8000* acts as the network coordinator. Also available is the 802.11 WiFi option for communicating directly to a standard RF access point. This option is covered by the WiFi for ScaleCore User Guide.

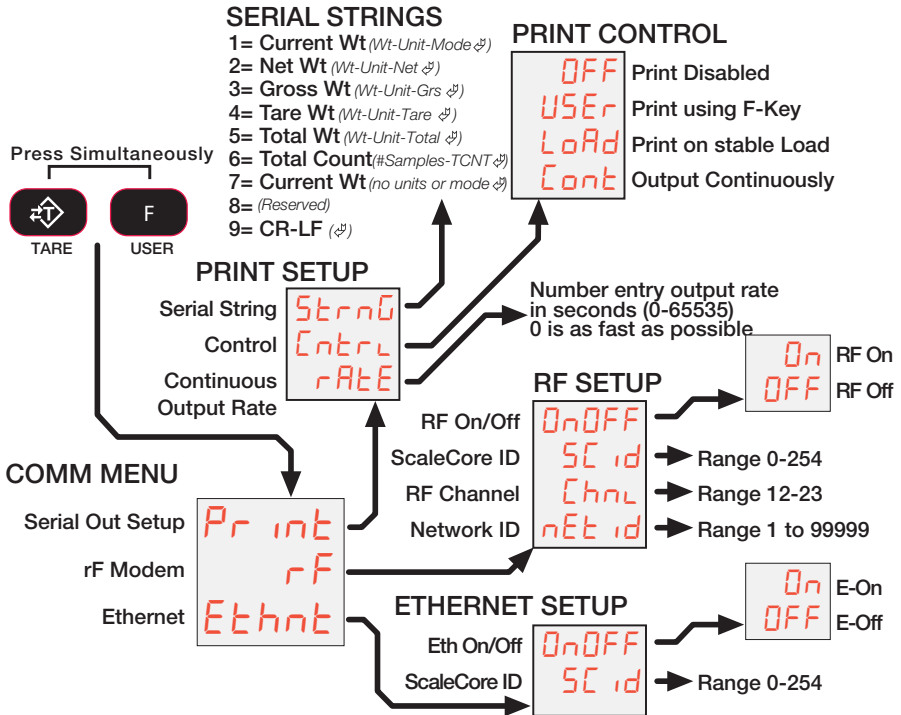

Figure 7-1. COMM Setup Menu

7.2 Printer/Serial Output Setup

The RS-232 comm port is capable of outputting tension data. All the weight modes the RF linked weight device can measure are available in user formatted form. The control mode programs are what causes the *MSI-3460* to print. The modes are:

- When an assigned F-Key is pressed, one transmission of the selected string type is output.
- On Load- When the tension on the link is stable, one transmission will output. Then the tension must return to zero to enable another print output.
- Continuous - program the interval in seconds up to 65,535 seconds. Setting the interval to 0 will set an interval as fast as the system can go.

To disable printing set the control mode to “OFF.”

The *MSI-3460* comm port settings are independent of the print settings in the connected *MSI-8000*. They reside only in the *MSI-3460*.

Far more complex print/serial strings can be introduced using MSI’s SCCMP setup program. See SCCMP User Guide for more details.

7.2.1 Control Modes

The user can select four control modes:

1. User - Printing is controlled by the operator pushing the PRINT key (usually F3).
2. Load - One print output when a stable load is reached. The scale must return to near zero before another print will occur. Other configurations of “On Load” are available using the SCCMP program.
3. Continuous - The *MSI-8000* will continuously output the data at a rate controlled by the *RATE* (RATE) menu.
4. OFF - Printing is disabled. Power consumption is lower with print off.

7.3 Standard Print Strings

1	Current Tension	Fixed output length: 16. Leading zeros suppressed except for the LSD. TTTTTTT sp UU sp MMMMM crlf Where TTTTTTT is tension data with -sign if necessary. UU is the units, MMMMM is the tension mode which for "1" is either NET or GROSS.
2	Net Tension	Fixed output length:16. Leading zeros suppressed except for the LSD. TTTTTTT sp UU sp NET spspcrlf
3	Gross Tension	Fixed output length: 16. Leading zeros suppressed except for the LSD. TTTTTTT sp UU sp GROSS crlf
4	Tare Weight	Fixed output length:16. Leading zeros suppressed except for the LSD. TTTTTTT sp UU sp TARE crlf
5	Total Weight	Fixed output length: 16. Leading zeros suppressed except for the LSD. TTTTTTTTT sp UU sp TTL crlf
6	Number of Samples Totalled	Fixed output length: 16. Leading zeros suppressed except for the LSD. spspspspspsp SSSSSSS sp T-CNT spcrlf
7	Current Weight Mode	Net, Gross, Peak, etc sp MMMMM crlf
8/9	Carriage Return/ Line Feed	Used to add a space between print records. crlf

Figure 7-2. Standard Print Strings

Printer / Output Setup

1) With the MSI-3460 on, press the **TARE** key and the **USER** keys simultaneously.

2) The LCD shows **Print**. Press **TARE**.

3) The sub-menu item **StrnG** (String) appears. Press **TARE**.

4) The current print code format number is displayed.

5) Set up a print format with one or more digits representing the data type required for the print output.

In this example, we'll set the Print format for a Net, Gross, Tare output with a carriage return/line feed between each print output. The number entry required will be 2349. The 2 is for Net weight, the 3 for Gross weight, the 4 for Tare weight, and the 9 inserts a space before the next print output.

6) Press the **USER** key to scroll through the digits until the desired digit is shown, then press **TARE** to enter the digit value. Repeat for the remaining digits.

7) When the entire number is displayed press **TARE**. The next item in the Print menu appears, **Ctrl**.

8) Press **TARE** to enter the print control menu. The last set control mode will appear.

9) To change the print control mode, press **USER**.
In this example, we'll set the print control mode to continuous.

10) Press **USER** key until the desired print control mode is shown.

11) When the desired print mode is shown, push **TARE** to save. The next print setup item, **rAtE** appears. If you have set continuous (cont) as your print control, proceed to step 12). For any other Control mode jump to step 15.

12) Press **TARE** to enter the print rate number entry screen. The current print rate appears on the LCD.

In this example, we'll set the print rate to an output rate of once every 2 seconds.

Press Simultaneously



- 1= Current Wt (Wt-Unit-Mode ⚡)
- 2= Net Wt (Wt-Unit-Net ⚡)
- 3= Gross Wt (Wt-Unit-Grs ⚡)
- 4= Tare Wt (Wt-Unit-Tare ⚡)
- 5= Total Wt (Wt-Unit-Total ⚡)
- 6= Total Count (#Samples-TCNT ⚡)
- 7= Current Wt (no units or mode ⚡)
- 8= (Reserved)
- 9= CR-LF (⚡)



The number represents the print interval rate in seconds. Use 0 for the fastest the MSI-8000 can go (~5 times per second). To set a once a minute transmission, set the rate to 60. To set once per hour, set the rate to 3600, etc. Largest possible entry is 65535 which is >18 hours.

Figure 7-3. Printer Output Setup

13) Press **USER** to change the Print rate. Scroll the number with the **USER** key. Enter each number with the **TARE** key.

14) When the entire number is displayed, press **TARE** again to finalize the seconds entry. The next Print Menu Item appears, **String**.

15) Exit the Print Setup Menu by pressing **ZERO** twice. The message **Store** appears briefly then normal system operation starts.

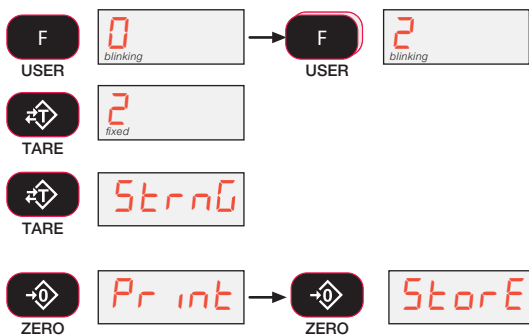

Figure 7-4. Printer Output Setup, Continued

7.4 802.15.4 RF Network Setup

(MSI-8000 Connection)

When equipped with the 802.15.4 option, the *MSI-3460* can connect with an *MSI-8000* remote display or an 802.15.4 modem. The *MSI-3460* uses three numbers to connect to an 802.15.4 piconet:

1. ScaleCore ID - This number is used to uniquely identify each ScaleCore device in a Piconet. It has a range of 0-254 and must not be duplicated within the same RF channel. For the *MSI-8000* as network coordinator, MSI recommends a number for the *MSI-3460* from 0-3 if multiple units will be connected to the *MSI-8000*. If a single *MSI-3460* is all that's needed, then any number up to 254 is acceptable.
2. RF Channel - Establishes the base network that all interconnected devices must match. This number must be in the range of 12-23.
3. Network ID - This is a 64 bit number that all interconnected devices must match. The *MSI-3460* limits this number to a max of 5 digits for a range of 0 - 99999. Do not use a small number here to help avoid other 802.15.4 networks that default to a Network ID of 0.

For all devices that must interconnect, the RF channel and Network ID must match. The ScaleCore ID must be unique. The *MSI-3460* or other MSI RF equipment that is a weight data source should be set to a ScaleCore ID of 0. Then if other slave devices are added, they can be added in sequence.

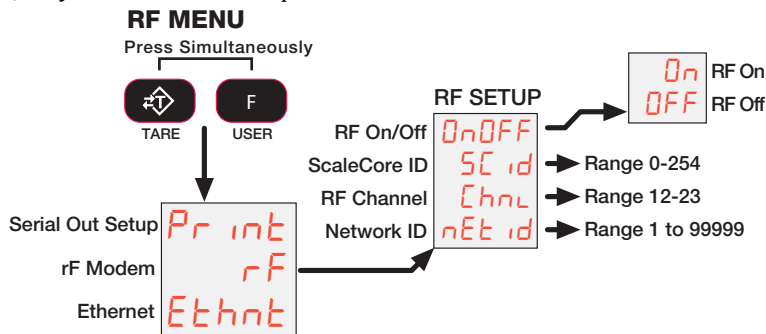

Figure 7-5. RF Menu

7.5 FCC Statement (for 802.15.4 Option)

Contains FCC ID: OUR-XBEEPRO

The enclosed device complies with Part 15 of the FCC rules. Operation is subject to the following two conditions: (i.) this device may not cause harmful interference and (ii.) this device must accept any interference received, including interference that may cause undesired operation.

7.6 RF Setup Procedure

RF Setup Procedure

- 1) With the power on, open the comm setup menu by pressing the **TARE** and **USER** keys simultaneously.

The COMM setup menu appears. The first menu choice is **Print**.

- 2) Press **USER** to scroll to the RF setup menus.

- 3) Press **TARE** to enter the RF setup menu.

- 4) The display reads **OnOff**. Confirm the 8000 RF is on by pressing **TARE**. If it is off, press **USER** key to change it to on. Then push **TARE**.

Off is only used when the 8000 is hardwired to a Dyna-Link.

- 5) Press **TARE**. Next the **Scid** (ScaleCore ID) screen is shown.

- 6) Press **TARE**. The current Scid number is shown.

*If the offered Scid value is correct, push **TARE** and jump to step 10.*

In this example we'll enter 3 as an SCID number. Any value from 1-254 is acceptable. However, MSI recommends a value from 20 – 30.

- 7) To input the SCID value, press **USER** to start the number entry process.

- 8) Press **USER** to change the number, and **TARE** to enter the number. Add the next digit by pressing **USER** and scrolling as required. Repeat this sequence until the entire SCID number is entered.

Press Simultaneously

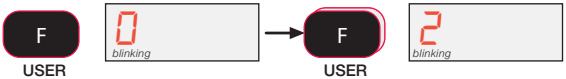

*Error Correction: If you input a wrong value, press **ZERO** to step back one digit and reenter.*

Figure 7-6. RF Setup Procedure

- 9) Once the entire SCID value is entered, press **TARE** to finalize the number.
- 10) The next RF setup parameter is **ChnL** (Channel). Press **TARE** to start the number entry process.
- 11) The current RF channel number is displayed.
*If the offered RF Channel value is correct, push **TARE** and jump to step 14.*
- 12) Press **USER** and using the previous process, enter the RF Channel number.
Recommended RF Channel numbers range from 12 to 23. In this example we'll use 21 as the RF Channel.
- 13) When the desired RF Channel number is shown and fixed, press **TARE**.
- 14) The next RF Setup Menu item is the **nEtID** (Network ID). Press **TARE** to see the current Net ID number.
*If the offered Network ID value is correct, push **TARE** and jump to step 17.*
- 15) Using the numeric entry process as before, input a network ID number. Press **F2** to start a new number.
Allowed Network ID numbers range from 0 to 99999. MSI recommends a random number of at least four digits to ensure that the 8000 system won't conflict with any other 802.11.4 networks (Zigbee).
- 16) When the final number is shown and fixed, press **TARE** to store the Network ID.
- 17) The RF Setup Menu goes to the first menu, **OnOff**. Press the **ZERO** key to exit out of the RF Setup Menus.
- 18) Press **ZERO** again to exit the COMM setup menu and store the new RF network numbers.

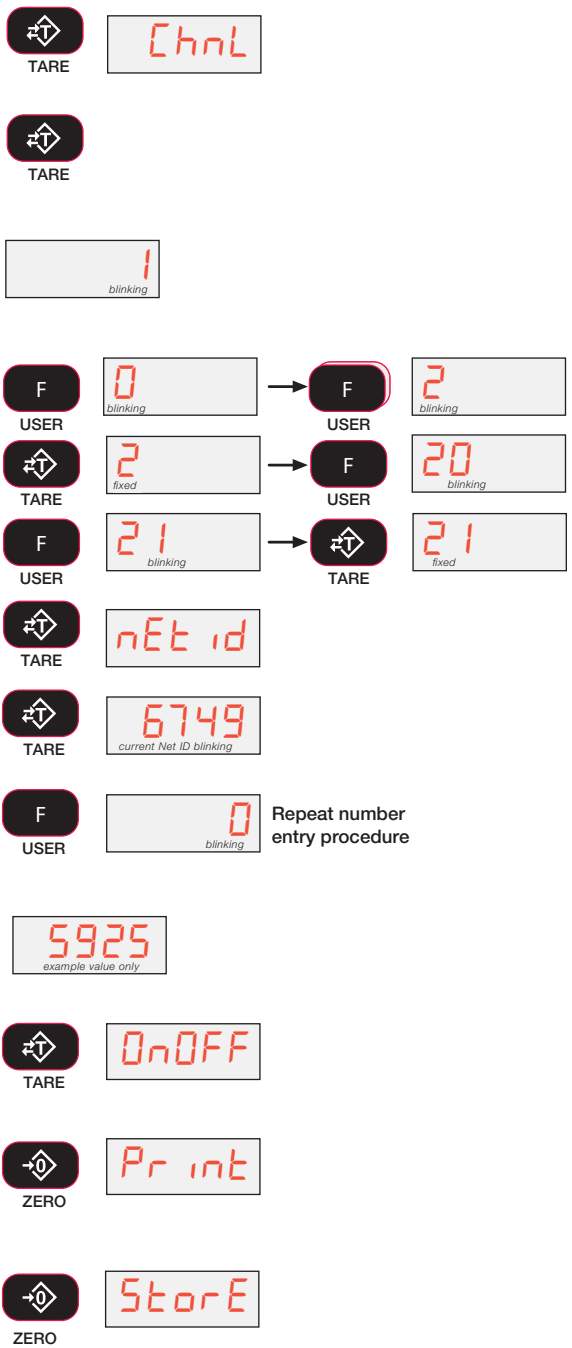

Figure 7-7. RF Setup Procedure, Continued

7.7 International RF CERTS (For 802.15.4 OPTION)

Canada Radio Cert. No.: IC: 4214A-XBEEPRO

Australia & New Zealand: AS4268:3000

Japan: Certificate of Radio Equipment in Japan No.: 08215111/AA/02

Europe and much of **Asia:**

This product is compliant with the following standards and/or other normative documents:

Safety (article 3.1A) EN60950-1:2001

EMC (article 3.1b) ETSI EN 301 489-17 v1.2.1 (2002-08)

Spectrum (article 3.2) ETSI EN 300 328 v1.7.1 (2006-10)

8.0 Appendix

8.1 Troubleshooting

Problem	Possible Cause	Solution
Display is blank when POWER button is depressed.	Discharged battery	Recharge, allow at least four hours charge.
	Defective battery	Replace
	Corroded battery or battery contacts	Clean contacts
	Defective switch or circuit board.	Requires authorized service.
Display does not function properly or front panel button does not function normally or scale will not turn off.	Improperly updated software.	Reinstall software
	Faulty circuit board	Requires authorized service.
	Loose connectors	Requires authorized service.
Scale does not respond to weight changes.	Out of calibration	Calibrate
	Faulty load cell	Replace
	Load cell connector	Check connector and wires.
Display over ranges below 100% capacity.	Tared weight is added to load to determine overload point.	Return to gross weight mode.
	Zero requires adjustment.	Rezero the scale
	Too much weight has been zeroed.	Rezero the scale
Display Drifts	AZM (Auto0) is turned off.	Turn AZM on
	Rapid temperature changes such as moving the scale from indoors to outdoors.	Wait until the scale temperature has stabilized.
Displayed weight shows large error.	Scale not zeroed before load is lifted.	Zero the scale with no load attached.
	lb/kg units causing confusion	Select proper units
	Requires recalibration	Recalibrate
Display reading not stable.	Excessive vibration in crane system.	Increase filtering or increase 'd' in cal.
	Excessive side loading	Improve load train symmetry
	Load cell faulty	Check LC connections
Display toggles between "Error" and "Load"	Weight exceeds capacity	Reduce weight immediately
	Faulty load cell or wiring	Check LC and LC wiring
Display toggles between "Error" and "A2DLo"	A/D is saturated negative	Check LC and LC wiring

Figure 8-1. Troubleshooting

Problem	Possible Cause	Solution
Display toggles between "Error" and "buttn"	A key is stuck or is being held down.	Check switches for damage
		Ensure that a remote is not transmitting continuously.
RF remote does not work.	Units not mated	See Setting the Transmitter (Section 6.3) and Receiver (Section 6.4) address procedures.
Some RF remote keys do not work but the ACK light blinks.	Keys were not enabled during the setup process.	Enable keys by running the transmitter and receiver address procedures.
Lo Batt is blinking	Battery is low	Recharge battery
Unit turns on, then immediately off.	Battery is low	Recharge battery
Weight will not zero	System not stable	Wait for motion light to turn off
		Increase filtering for more stability
	Zero out of range	LFT units have limited zero range. Reduce the weight or use tare instead
Weight will not tare or total	System is not stable	Wait for motion light to turn off, or if in a mechanically noisy crane, increase the filtering or reduce the size of the scale increment 'd.' It is also possible to increase the motion window. Contact MSI if you have a problem getting the MSI-3460 to zero, tare, or total due to stability issues.
Setpoint lights blink	Setpoint is enabled and the trigger point has been reached.	Disable setpoints if they are not needed.
Manual total does not work	A function key is not set to "Total"	Set up Func1 or Func2 for "Total"
	Weight must be stable	Increase filtering for more stability

Figure 8-1. Troubleshooting

Problem	Possible Cause	Solution
Auto total does not work	Weight must be stable	Wait for the motion light to go out, or increase filtering for more stability
	Weight thresholds not reached	You must exceed 1% of capacity for autototal to work. Then you must drop below 0.5% of capacity for additional weightments to register.

Figure 8-1. Troubleshooting

8.1.1 Service Counters

The MSI-3460 maintains two service counters for safety.

- The first counter counts the number of times the scale has been overloaded.
- The second counter counts lifts above 25% of capacity.

These counters serve to warn the user to inspect the load train after a number of overloads, also when there is a chance of fatigue failure. The power up routine will be interrupted when the lift counter exceeds 16383 lifts or the overload counter exceeds 1023 overloads. If the screen displays LFCNT when unit is powered on :

1. Push TARE to display the 25% lift counter.
2. Push TARE again to see the overload lift counter.
3. Push the ZERO key to acknowledge the warning and return to standard scale operation.



Note *The power up warning message won't appear again for another 16383 lifts (or 1023 overloads).*

To access the service counters:

4. Program a user function key to be TEST (see function key setup).
5. Press TEST (USER).
6. Within two seconds of pressing the TEST (USER) key, press TARE.
7. The display flashes “LFCnt” (for Lift Counter) followed by the number of times the weight has exceeded 25% of capacity.
8. Press TEST (USER). The display flashes “OLCnt” (for Overload Counter) followed by the number of times the weight has exceeded capacity.
9. Press TEST (USER). The display flashes the C-Cal value.
10. Press TEST (USER). Returns to standard weighing mode.



WARNING *Only a MSI factory representative can reset the service counters, as these are important safety warning features. Depending on the circumstances, a thorough load train inspection might be necessary to ensure user safety.*

Reference MSI's “Crane Scale Safety and Periodic Maintenance manual” (Pub. 243-08-94D) for proper loading techniques to improve the safety and longevity of your MSI-3460 crane scale. This publication is available at www.msiscales.com and is included in the CD shipped with your crane scale.

8.2 Software Update for use with SC3 PCA

Equipment Requirements:

- PC with terminal program
- 3460 Interface Cable PN: 503230-0001 (10') or -0002 (5')

Updating Process

1. Connect interface cable to P2, as shown.

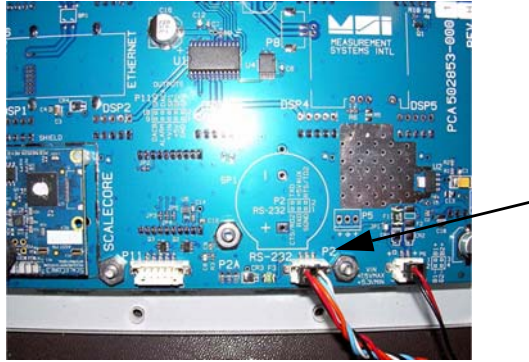

Figure 8-1. Connecting Interface Cable

2. Power on the scale.
3. Open a terminal program.

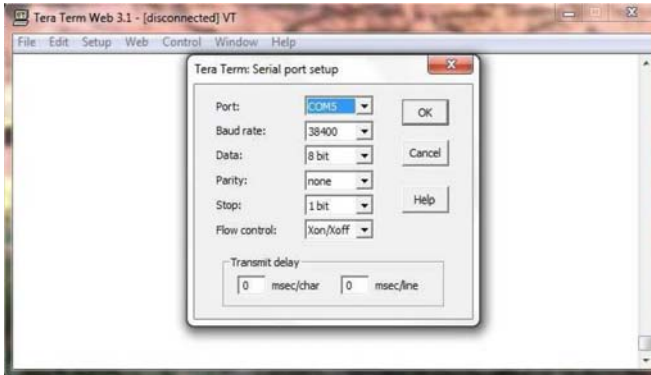

Figure 8-2. Serial Port Setup

4. Configure to the following:
 - Baud Rate: 38400
 - Data Bits: 8
 - Parity: None
 - Stop Bits: 1
 - Flow Control: XON/XOFF

- Type: {00FF09=0199}, then press enter. This command will access the boot-loader program within the SCALECORE. “bLOAD” displays on the MSI-3460 and the Scalecore Boot Loader menu will appear on the terminal screen



MSI-3460 Display

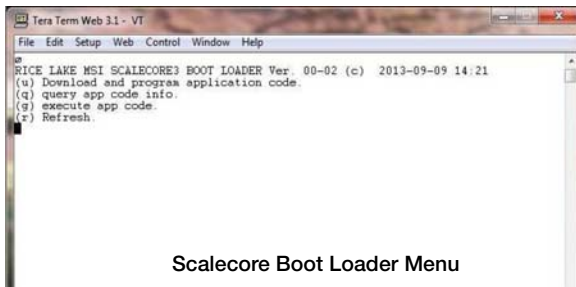

Scalecore Boot Loader Menu

Figure 8-3. Access Bootloader Within Scalecore

- Type u to download and program the application code. Boot Loader program will prompt to send file.
- Select file, then send. Wait for complete file transfer.

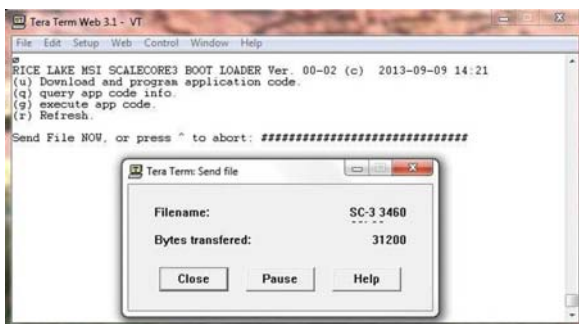

Figure 8-4. Send File

When complete, Boot Loader Menu will appear on terminal screen.

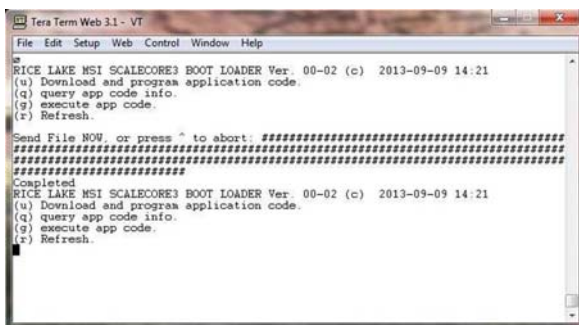

Figure 8-5. Bootloader Menu

8. Verify Application Code Version, type q to query app code info.
- App Code Version: 03b03

 **Note** Contact MSI for current version.

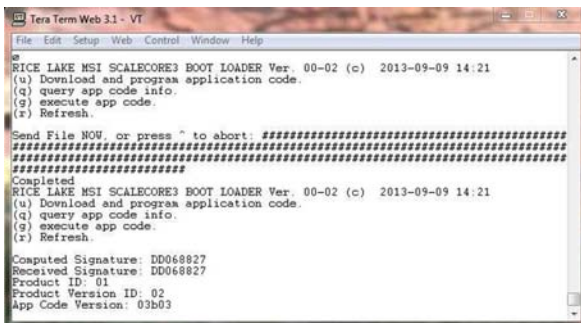

Figure 8-6. Query App Code Info

9. Type g to execute application code, the MSI-3460 display will return to normal weighing mode.



Figure 8-7. Normal Weighing Mode

8.3 MSI-3460 Challenger 3 Dimensions

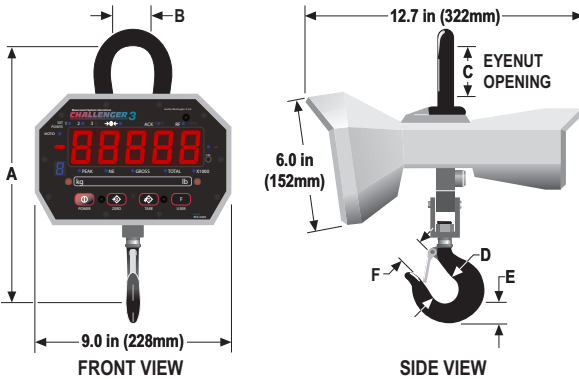

Note: 15,000 lb (7,000 kg) unit comes standard with 12 ton top shackle.

Capacity	Resolution	A	B	C	D	E	F	Approximate Shipping Weight
250 lb	0.1 lb	11.94 in	2.0 in	2.45 in	1.63 in	1.14 in	1.16 in	22 lb
125 kg	.05 kg	303 mm	51 mm	62 mm	41 mm	29 mm	29 mm	10 kg
500 lb	0.2 lb	11.94 in	2.0 in	2.45 in	1.63 in	1.14 in	1.16 in	22 lb
250 kg	0.1 kg	303 mm	51 mm	62 mm	41 mm	29 mm	29 mm	10 kg
1,000 lb	0.5 lb	11.94 in	2.0 in	2.45 in	1.63 in	1.14 in	1.16 in	22 lb
500 kg	0.2 kg	303 mm	51 mm	62 mm	41 mm	29 mm	29 mm	10 kg
2,000 lb	1.0 lb	11.94 in	2.0 in	2.45 in	1.63 in	1.14 in	1.16 in	22 lb
1,000 kg	0.5 kg	303 mm	51 mm	62 mm	41 mm	29 mm	29 mm	10 kg
5,000 lb	2.0 lb	16.67 in	2.45 in	3.40 in	2.5 in	1.81 in	1.61 in	39 lb
2,500 kg	1.0 kg	423 mm	62 mm	86 mm	64 mm	46 mm	41 mm	18 kg
10,000 lb	5.0 lb	16.67 in	2.45 in	3.40 in	2.5 in	1.81 in	1.61 in	39 lb
5,000 kg	2.0 kg	423 mm	62 mm	86 mm	64 mm	46 mm	41 mm	18 kg
15,000 lb	5.0 lb	16.67 in	2.45 in	3.40 in	2.5 in	1.81 in	1.61 in	39 lb
7,500 kg	2.0 kg	423 mm	62 mm	86 mm	64 mm	46 mm	41 mm	18 kg

Figure 8-8. MSI-3460 Challenger 3 Dimensions

The MSI Limited Warranty

MEASUREMENT SYSTEMS INTERNATIONAL, INC., WARRANTS load sensing elements and meters against defects in workmanship and materials for a period of one year from date of purchase and warrants electrical cables and batteries against the same defects for a period of ninety (90) days from date of purchase.

Any device which proves defective during the warranty period will be replaced or repaired at no charge; provided that the defective device is returned to the Company freight pre-paid.

In no event shall the Company be liable for the cost of any repairs or alterations made by others except those repairs or alterations made with its specific written consent, nor shall the Company be liable for any damages or delays whether caused by defective workmanship, materials or otherwise.

The Company shall not be liable for any personal injury or property damage resulting from the handling, possession or use of the equipment by the customer.

The warranty set forth herein is exclusive and is expressly in lieu of all other warranties, express or implied, including without limitation any implied warranties of merchantability or fitness, or of any other obligations or liability on the part of the Company.

The liability of the Company under this warranty is limited solely to repairing or replacing its products during the warranty periods; and the final judgment and disposition of all claims will be made by MEASUREMENT SYSTEMS INTERNATIONAL, INC.

Notes

Notes

Notes



Measurement Systems International™

A RICE LAKE WEIGHING SYSTEMS COMPANY

14240 Interurban Avenue South Suite 200 • Seattle, WA 98168-4661 • USA

Phone: 206-433-0199 • Fax: 206-244-8470

www.msiscales.com

www.ricelake.com www.ricelake.mx www.ricelake.eu www.ricelake.co.in m.ricelake.com